

**LINSEIS**

*pushing boundaries*

**STA L81**

Simultaneous  
**Thermal  
Analysis**

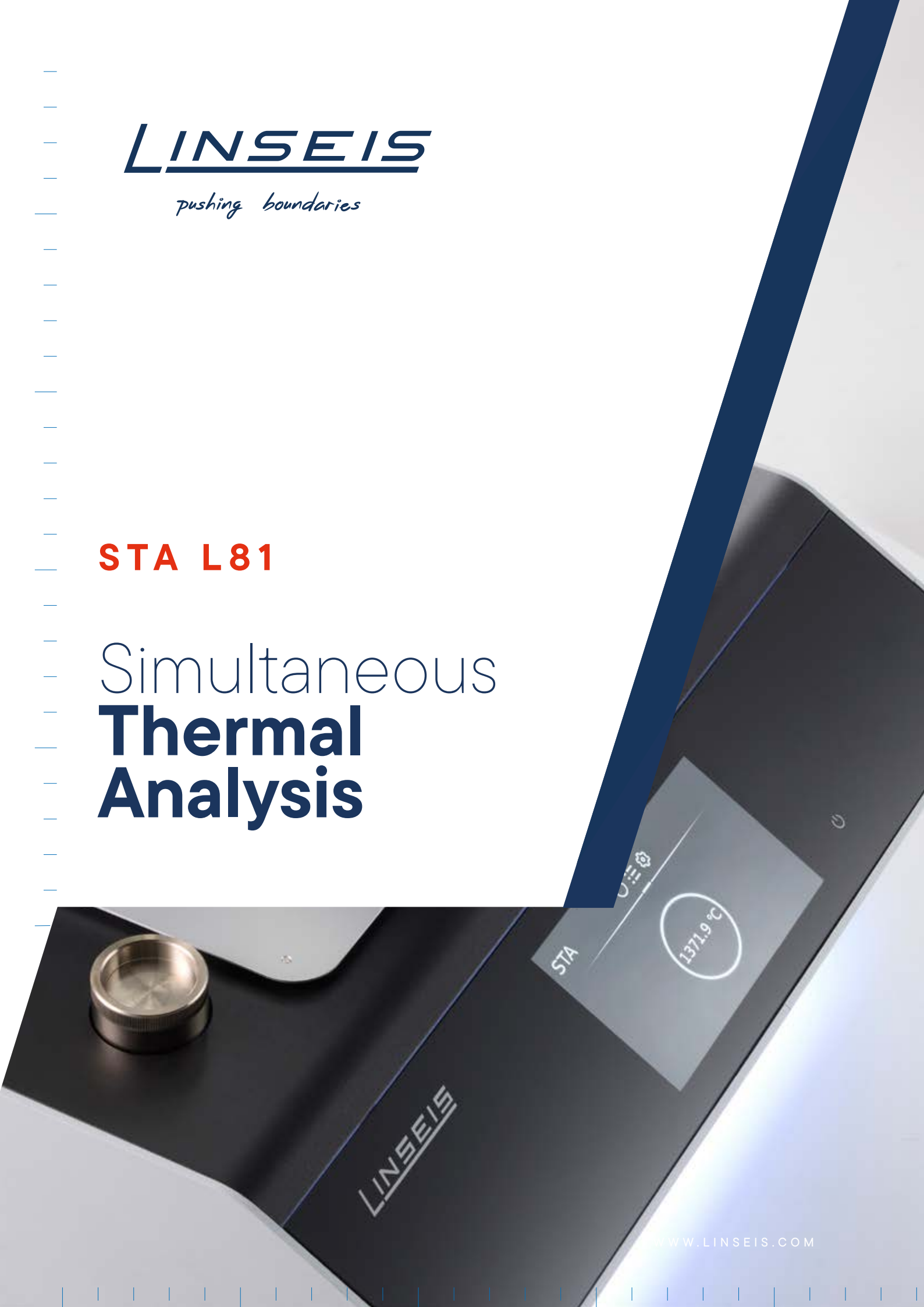



Since 1957 LINSEIS Corporation has been delivering outstanding service, know-how and leading innovative products in the field of thermal analysis and thermo-physical properties.

Customer satisfaction, innovation, flexibility, and high quality are what LINSEIS represents. Thanks to these fundamentals, our company enjoys an exceptional reputation among the leading scientific and industrial organizations. LINSEIS has been offering highly innovative benchmark products for many years.

The LINSEIS business unit of thermal analysis is involved in the complete range of thermoanalytical equipment for R&D as well as quality control. We support applications in sectors such as polymers, chemical industry, inorganic building materials, and environmental analytics. In addition, thermophysical properties of solids, liquids, and melts can be analyzed.

Rooted in a strong family tradition, LINSEIS is proudly steered into its third generation, maintaining its core values and commitment to excellence, which have been passed down through the family leadership. This generational continuity strengthens our dedication to innovation and quality, embodying the essence of a true family-run business.

LINSEIS provides technological leadership. We develop and manufacture thermoanalytic and thermophysical testing equipment to the highest standards and precision. Due to our innovative drive and precision, we are a leading manufacturer of thermal analysis equipment.

The development of thermoanalytical testing machines requires significant research and a high degree of precision. LINSEIS Corp. invests in this research to the benefit of our customers.

CLAUS LINSEIS  
CEO DIPL. PHYS.



To strive for the best due diligence and accountability is part of our DNA. Our history is affected by German engineering and strict quality control.

We want to deliver the latest and best technology for our customers. LINSEIS continues to innovate and enhance our existing thermal analyzers. Our goal is to constantly develop new technologies to enable continued discovery in Science.

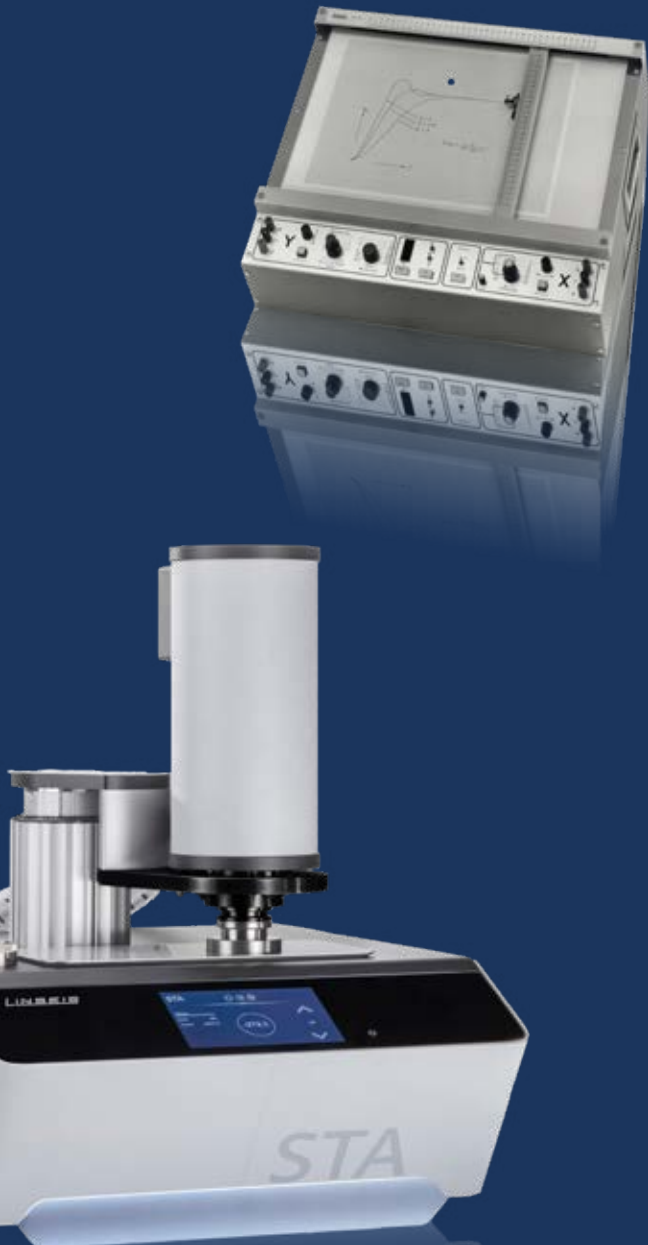

# Engineering & Innovation

# Simultaneous Thermal Analysis

Simultaneous TGA-DTA/DSC measures both, **heat flow** and **weight change** of a sample as a function of temperature or time under controlled atmosphere. Simultaneous measurement of these two material properties not only improves productivity but also simplifies interpretation of the results. The complimentary information obtained allows differentiation between endothermic and exothermic events which have no associated weight change (e.g., melting and crystallization) and those which involve a weight change (e.g., degradation).

## STA

(Simultaneous Thermal Analysis)

## DSC

(Differential Scanning Calorimeter)

## TGA

(Thermogravimetry)



# DSC-True Heat Flow measurement

## Quantitative DSC-signal

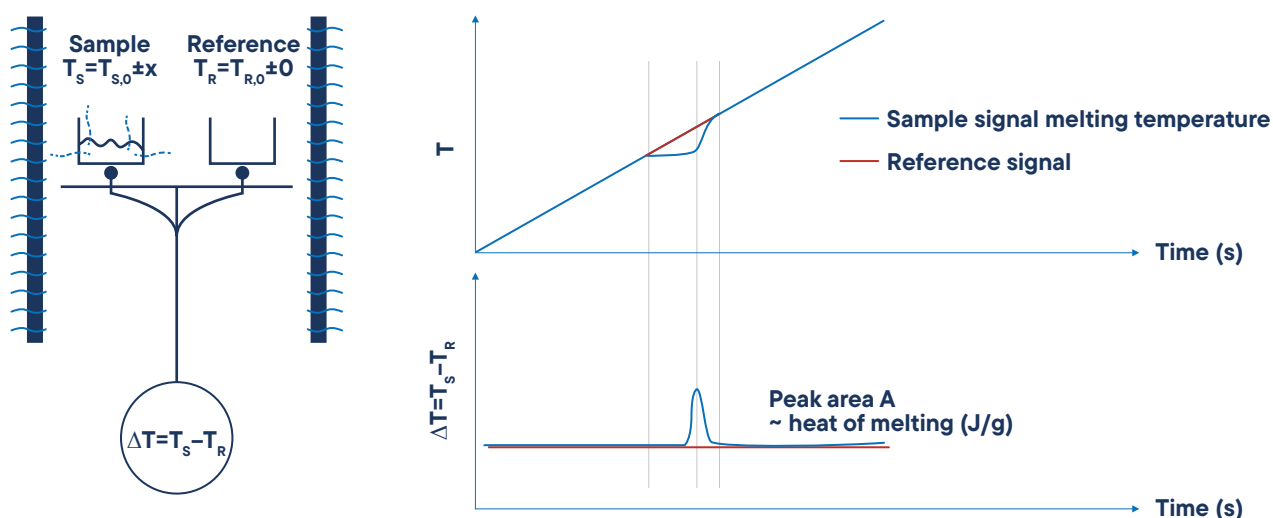

### Differential Scanning Calorimetry (DSC)

A technique in which the difference in energy input into a substance and a reference material is measured as a function of temperature, while the substance and reference material are subjected to a controlled temperature program.

### Differential Signal

The differential signal is displayed as a baseline. Effects, for example the melting of a metal, can be observed as a peak. The area of the peak gives the amount of enthalpy and the direction of the peak indicates the way of heat flux – endothermic (down) or exothermic (up).

### Temperature vs. Time

During an effect like a reaction, decomposition or phase transition, a temperature difference (heat flux difference) between the sample and the reference crucible can be measured by means of a thermocouple.

### Measurable Properties

- Mass change in % and mg
- Rate controlled mass loss
- Evaluation of mass loss
- Residue mass evaluation
- Compositional analysis
- Enthalpy
- Endo- / exothermic reaction
- Phase transition
- Melting point
- Glass point
- Crystallinity
- Thermal stability
- Oxidation stability
- Purity
- Solidus / Liquidus relationship
- Product identification

# Sensors

The Linseis STA can be equipped with an unmatched amount of different user exchangeable TG-DSC, TG-DTA or TG sensors. Each sensor is available with different thermocouples to provide the highest sensitivity for the desired temperature range and application. Additionally, there are multiple crucible types available that enables the user to find the matching combination for his application.

- Al<sub>2</sub>O<sub>3</sub>
- Platinum
- Aluminium
- others

## TG-DSC

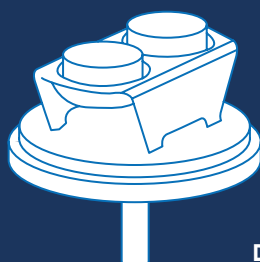
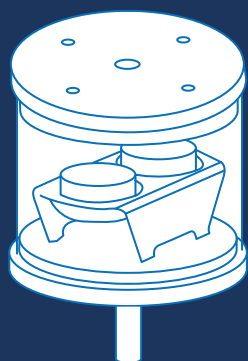

DSC Heat flux

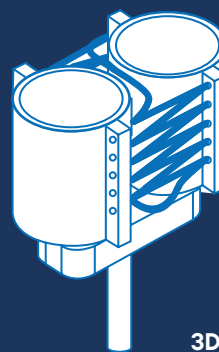

3D-Calvet-DSC sensor

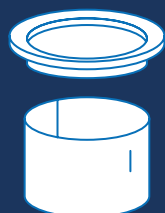

0.12 ml



0.12 ml



custom volume



# TG-DTA

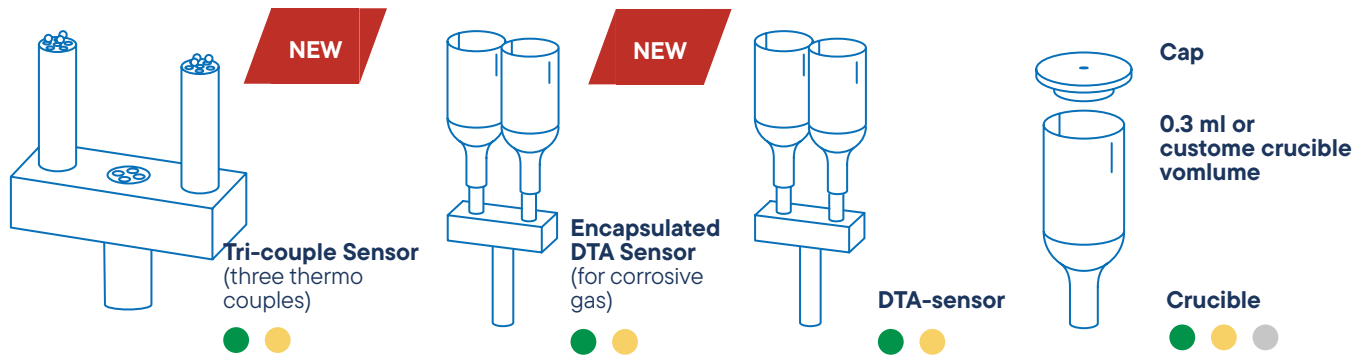

# TGA

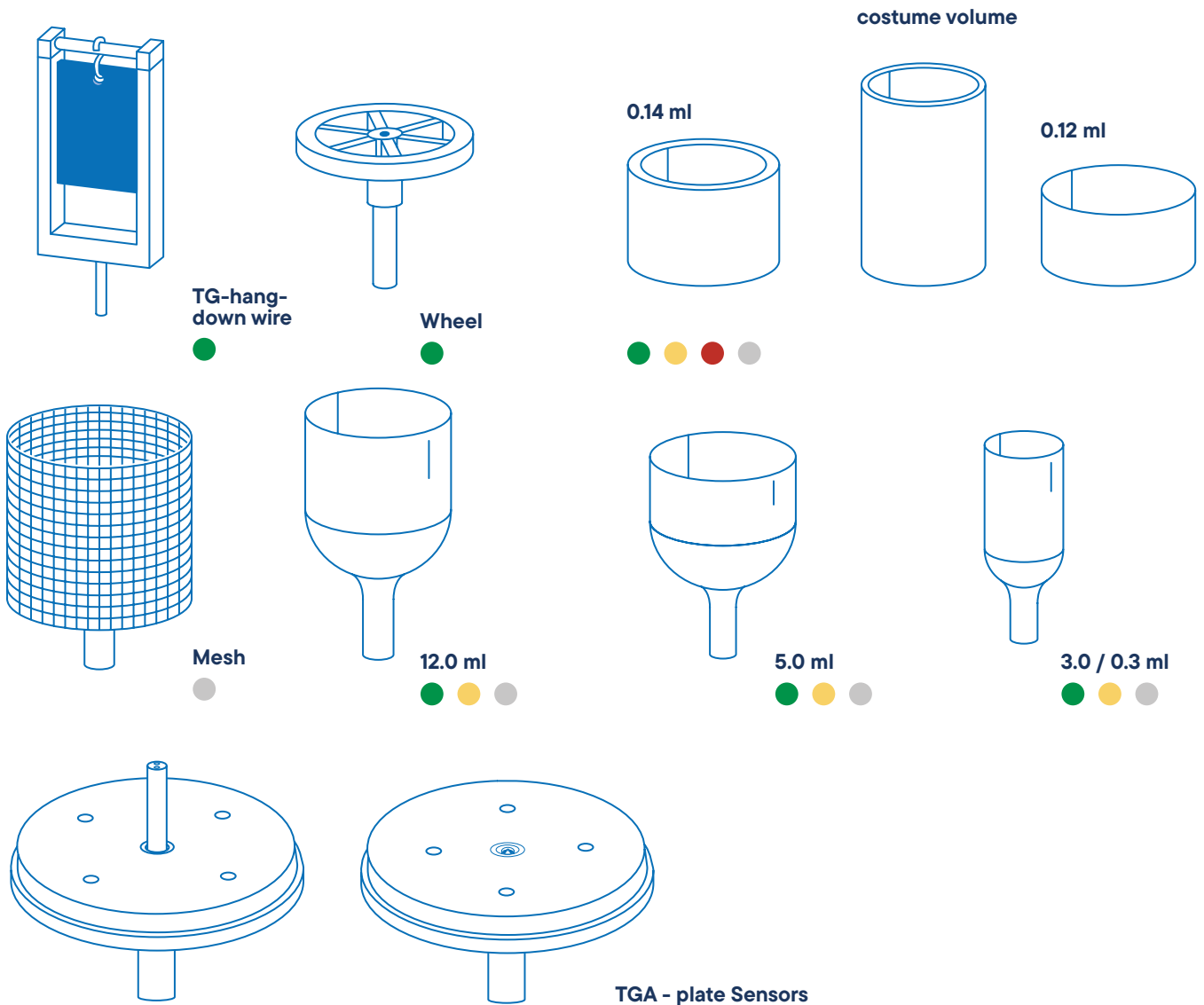

# Best possible sensitivity for every application

## Electromotive force / Temperature

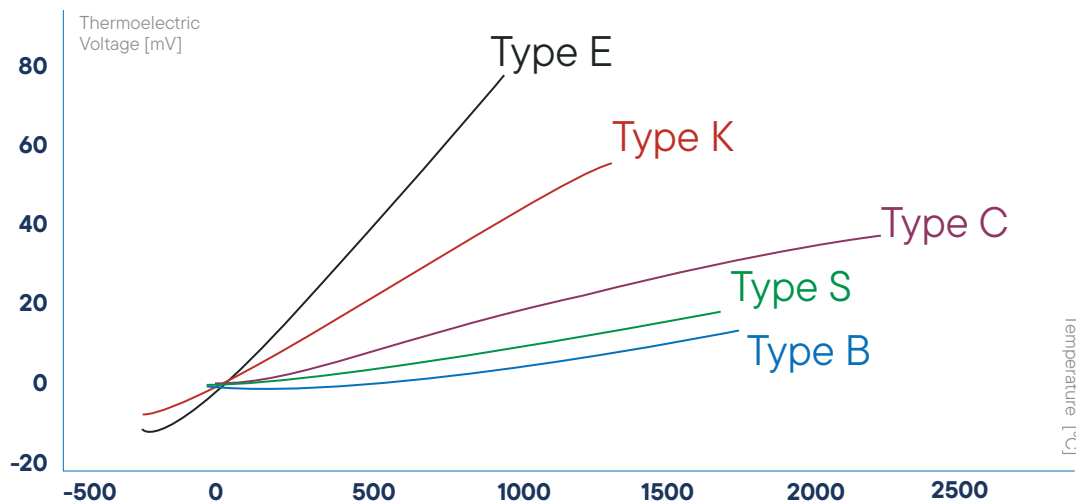

Thermocouple types:

Type E: Chromel: Constantan - -50 °C up to 900 °C

Type K: Chromel: Alumel - -180 °C up to 1100 °C

Type S: Platinum-Rhodium (10 %): Platinum - 0 °C up to 1600 °C

Type B: Platinum-Rhodium (30 %): Platinum-Rhodium (6 %) - 25 °C up to 1800 °C

Type C: Tungsten (5 %)-Rhenium: Tungsten (26 %)-Rhenium - 20 °C up to 2300 °C

All sensors available with the thermocouples illustrated. LINSEIS sensor combinations cover the broadest temperature range in the market (-180 °C up to 2400 °C).

## Furnace Programm

Temperature	Type	Element	Atmosphere	TC-Type
-70°C - 400°C	L81/264/RCF	HangDown only Intracooler / Kanthal	inert, oxid., red., vac.	K
-150°C - 500°C	L81/264/500	Kanthal	inert, oxid., red., vac.	K
-150°C - 700°C	L81/264/700	Kanthal	inert, oxid., red., vac.	K
-150°C - 1000°C	L81/264/1000	Kanthal	inert, oxid., red., vac.	K
RT - 1000°C	L81/220 AC	SiC	inert, oxid., red., vac.	K
RT - 1600°C	L81/240 AC	SiC	inert, oxid., red., vac.	S
RT - 1750°C	L81/250	MoSi <sub>2</sub>	inert, oxid., vac.	B
RT - 2000°C	L81/260/G/2000	Graphite	inert, red.	C
RT - 2400°C	L81/260/G/2400	Graphite	inert, red.	Pyrometer
RT - 2800°C	L81/260/G/2800	Graphite	inert, red.	Pyrometer
RT - 2400°C	L81/260/T	Tungsten	inert, red.	C
RT - 1000°C	L81/200	Glow igniter	inert, oxid., red., vac.	S/K



# Benefits of the vertical top loading design

The vertical “sample on top” design of the LINSEIS thermo-balance provides highest possible accuracy due to a stable position of the sample and easy sample handling.

TGA/ STA PT 1000/1600

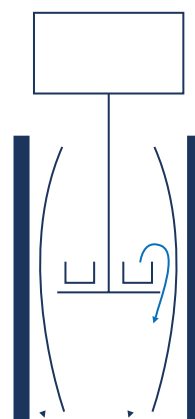
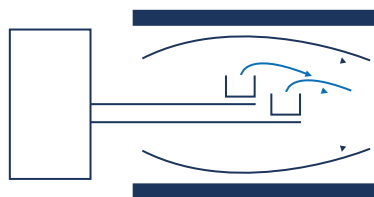
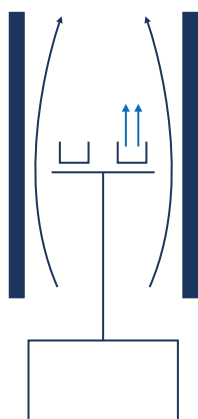

## Vertical system (sample on top) LINSEIS configuration

### Advantages:

- Easy sample handling
- Easy exchange of sample holder
- Stable position of the sample in the furnace

(critical for good DTA/DSC and Cp results)

### Disadvantage:

- Complicated construction

## Horizontal system

### Advantages:

- Small buoyancy effects

### Disadvantages:

- Very difficult sensor exchange
- Difficult sample handling
- Very high purge gas rate required
- Problems due to sensor expansion during heating/cooling

## Vertical system (sample on bottom)

### Advantage:

- Stable position within furnace

### Disadvantages:

- Difficult sensor exchange
- “Dangerous” gas flow within balance housing (sample gets blown out)
- Sensor position depends on sample weight



# New features

## Electronic Upgrade

The new measuring electronics offer significant performance improvements, inspired by the architecture of the „Linseis Digital Balance“. The benefits of this new digital balance architecture include:

- **Minimization of drift:** Ensures consistently high precision over long periods of time.
- **Improved resolution:** Unique sub-microgram resolution.
- **Highest accuracy:** Improves the reliability of your measurement results.
- **Reproducibility:** Ensures consistent results with repeated measurements.

## Linseis Lab Link

With Linseis Lab Link, we offer an integrated solution to address uncertainties in measurement results. With direct access to our application experts via the software, you can get advice on the correct measurement procedure and evaluation of results. This direct communication ensures optimal results and maximizes the efficiency of your measurements for precise analysis and research as well as a smooth process flow.

## Software Improvements

- **Lex Bus Plug & Play:** Our latest hardware interface Lex Bus revolutionizes the way data communicates within our systems. Lex Bus enables seamless and efficient integration of new hardware and software tools.
- **Improved furnace control:** Our new and further improved furnace control offers a faster heating and cooling as well as more precise temperature control, which leads to better measurement results through better temperature sequencing according to your wishes and requirements.
- **New software with user interface:** Our communication is now even more focused on the needs of our customers to ensure that you are always informed of the latest status and receive support whenever it is needed.
- **Process security:** We have optimized our software for process security to ensure that your data is protected at all times and processed in a fail-safe manner.
- **Error messages and bug fixes:** Our system automatically detects errors and bugs, which are immediately documented and fixed to minimize downtime.
- **Automatic updates and new features:** Our software receives regular automatic updates that not only improve security, but also continuously provide new features.
- **Permanent system monitoring:** Our software constantly monitors the system parameters to ensure optimum performance.
- **Preventive maintenance and problem detection:** Our preventive maintenance approach detects problems and wear and tear before they can cause damage and keeps your device in top shape.

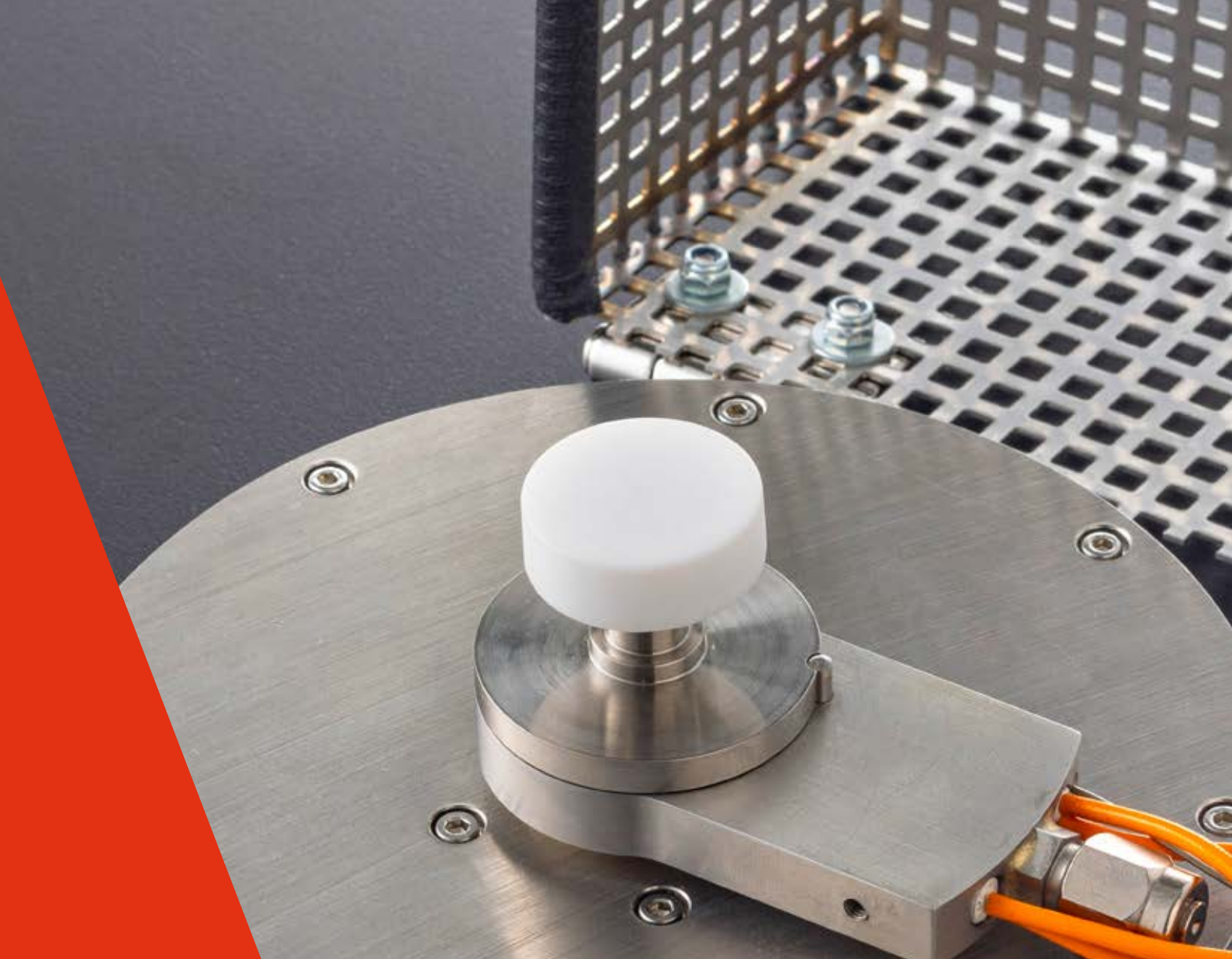

## Design Improvements

The new device design is characterized by an elegant aluminum casing that is both robust and aesthetically pleasing. The LED status bar provides a user-friendly visualization of important information. A touch panel enables intuitive operation and contributes to a modern user experience that combines comfort and functionality. The new device design focuses on ergonomic operation.

## New Hardware Features

- **Tri-couple DTA measuring system:** DTA measuring system with three thermocouples for the smallest endo-/exothermic effects in inhomogeneous samples
- **Jacketed DTA measuring system:** For corrosive samples
- **Patented „forced flow“ method:** Enables forced flow through your TG or TG-DTA. Our system enables forced flow through the sample, where by up to 100 % reaction gas is fed directly to the sample. This novel method enables scalable measurements for the first time, allowing precise analysis under real conditions.

# Unique features

## Automatic Evacuation

The devices feature a built-in automatic evacuation capability, ensuring efficient processes and smooth operation.

## Vacuum and controlled atmosphere

- Supports high vacuum, inert, reducing, oxidizing, or humidified atmospheres
- Optional pressurization up to 5 bar overpressure
- Analysis of certain corrosive conditions with precautions
- Adaptability for residual gas analysis with optional heated capillary

## Evolved gas analysis

Optional gas analysis with MS, FTIR, or GCMS is possible, providing valuable additional information. The system can be configured with standalone and integrated MFC for gas dosing. Additionally, customer-specific options such as a heated inlet can also be integrated into the device.

## Gas safety system

The gas safety system is designed to accommodate various gases such as hydrogen or carbon dioxide, ensuring secure operation and user safety.

## Controlled humidity and water vapour

The device can regulate the humidity and water vapour during the measurement.

## Sample robot

Our STA L81 can be equipped with a proven sample robot for unattended sample measurements for highest throughput.

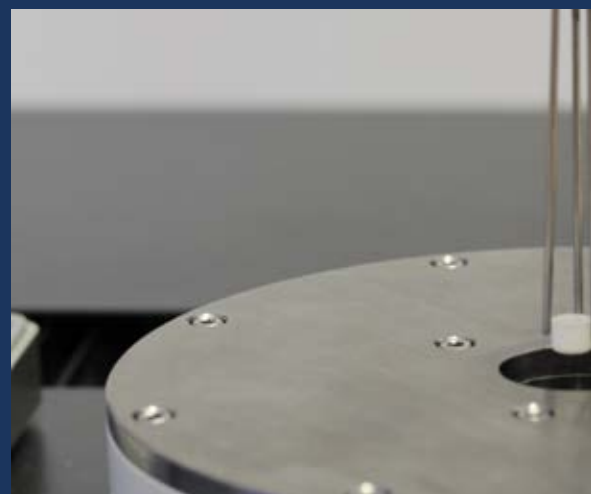

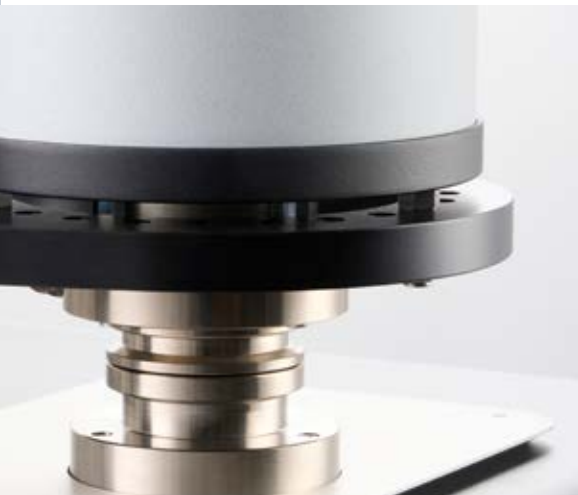

### Wide temperature range -150 °C to 2400 °C

The LINSEIS STA instruments can be equipped with up to two furnaces at the same time. A broad variety of different furnaces are available to enable measurements in the widest temperature range on the market.

### Automatic calibration

We offer an automatic calibration function in the software and hardware. With this function, our STA automatically calculates a calibration factor, which is also displayed.

### Integrated LINSEIS platform

The integrated LINSEIS software offers a comprehensive solution, combining both hardware and software for maximum process security and precision. By providing a unified platform, it ensures seamless integration of components and devices from external partners, resulting in a highly robust system.



### Customization

Close collaboration with the customers to tailor unique solutions, leveraging LINSEIS expertise to meet their specific needs.

### Service

Our international presence across every continent enables us to deliver the best and fastest service possible.

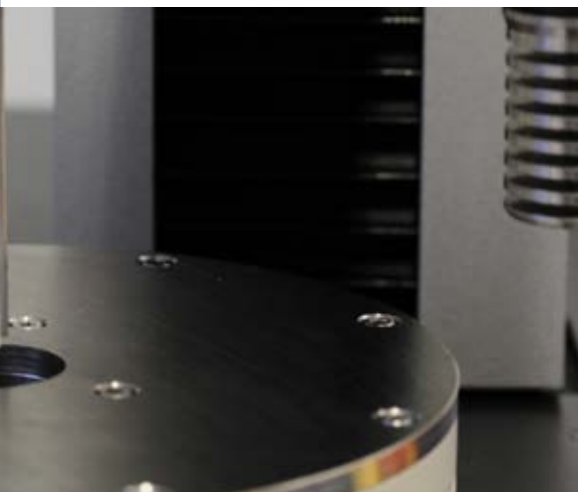

### Accessories starter kit

The accessory starter kit guarantees fast and uncomplicated usage, serving as a complete system for instant application.





## Equipment for gas control and safety (H<sub>2</sub>, CO, CO<sub>2</sub>, etc...)

All Linseis instruments can be prepared for the use in hydrogen atmosphere with just minor adjustments. The most important thing is a safety system that can ensure that there is no leakage and no explosive atmosphere generated outside of the instrument. Therefore, the Linseis safety system uses hydrogen sensors that are coupled to an automatic gas control panel. If there is a leakage or unwanted hydrogen release, the instrument is automatically flooded with inert gas and the hydrogen valves are closed. This ensures a minimum risk level during operation. Besides that, the system contains an optional burn off unit where the gas outlet is connected to, to ensure that also the used gas of the measurement chamber is not just released into the environment. The system can also be operated with several combinations of inert gases and even water vapor besides hydrogen.

### In summary, the Linseis safety system comes with the following benefits:

- Automatic evacuation function
- Gas flow control for multiple gases including water vapor and hydrogen
- Emergency shutdown function
- Gas detector system (H<sub>2</sub>, CO, CO<sub>2</sub>, etc...)
- optional burn off unit
- Continuous monitoring to ensure safe operating conditions



Fig. 1

# Linseis equipment for operation under water vapor and controlled relative humidity



For many applications in thermal analysis, the atmosphere plays an important role as it may affect the sample behavior or activate reactions. Humidity influence on building materials, storage time of pharmaceuticals and foods or influence on mechanical properties of polymers are just some of the most common examples. Of course, the Linseis instruments are suitable for such experiments, however there is one fact that is often causing confusion and must be considered carefully: The difference between water vapor and relative humidity.

Relative Humidity Generators are most commonly used for experiments around room temperature, while water vapor applications are most often at higher temperatures. When water is heated to its boiling point or higher than that, the water changes its aggregate form from liquid to gaseous. It is then existing as water vapor (steam). If this steam is introduced into any kind of reaction chamber or instrument, it is called water vapor application. In contrast, every gas can transport and contain a certain amount of water at a given temperature. This is called humidity. Considering air as an example, there is always an amount of water contained in the air, even below the boiling point of water, which is defined as grade of humidity or relative humidity.



## Highest precision beam balance

Our different microbalances are specifically designed to accomplish thermal analysis tasks in the best possible way.

Providing ultra light weight design to follow fast weight changes and symmetric construction for ultra low drift long term measurements.

Linseis micro balance  
especially designed for  
thermal  
analysis instruments

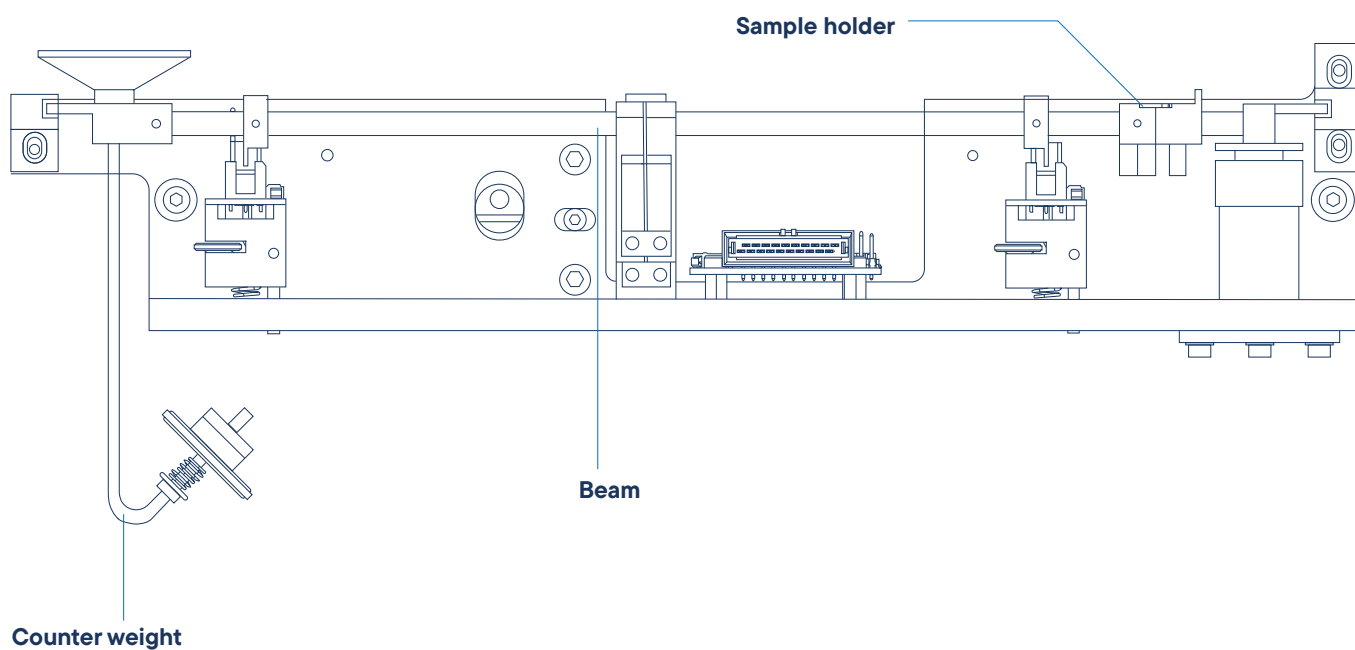



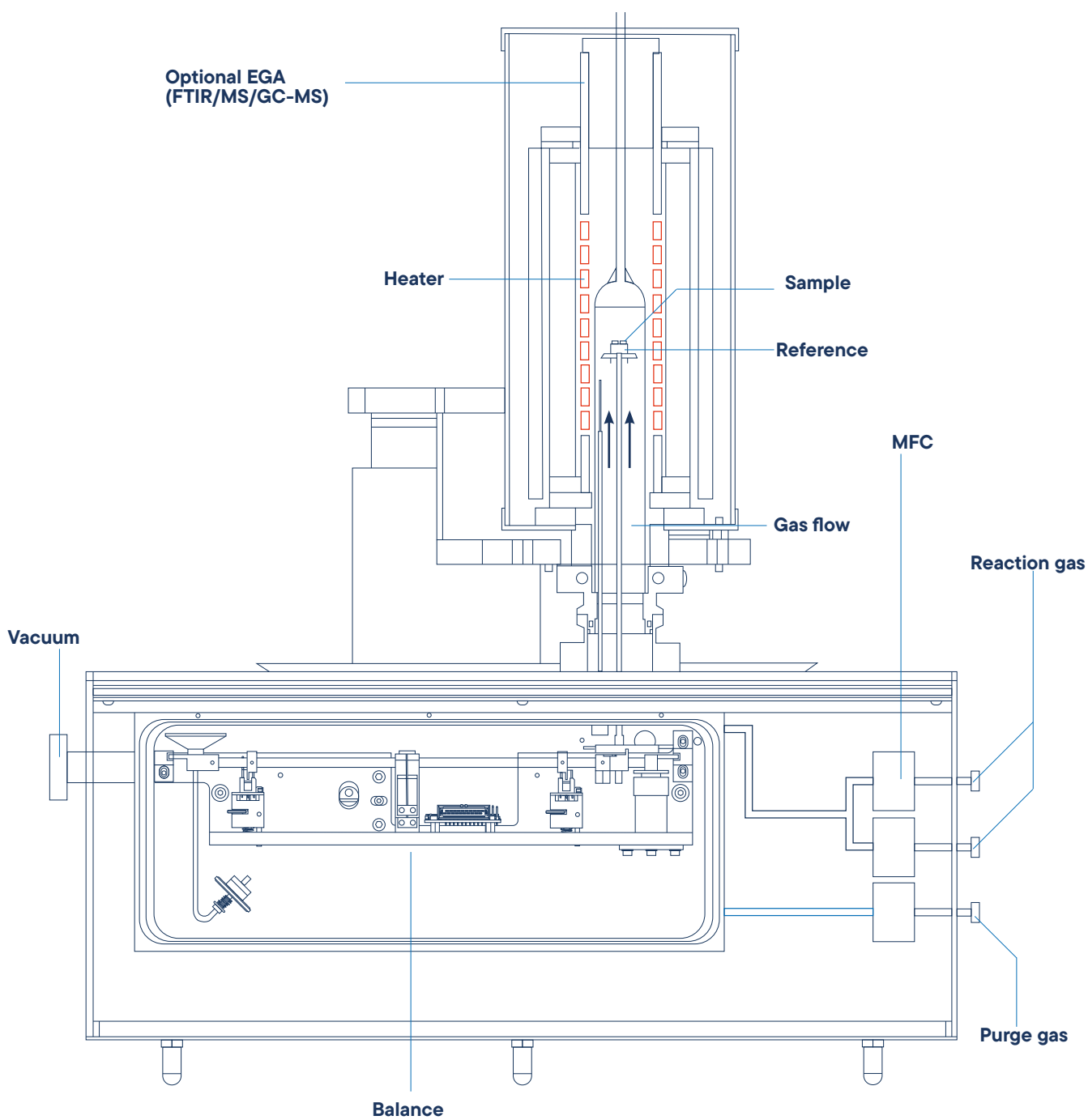

### Advantages of LINSEIS balance design

- Sample mass compensation by a counterweight enables improved sensitivity
- Improve symmetrical design for high interference levels
- Not affected by local gravity
- Not affected by thermal fluctuations

- Highest possible PRECISION
- Concept enables easy maintenance
- Depending on model, balance can handle from mg up to 50 g sample mass

### Advantages of combined TG+DSC

- Same geometry
- Stoichiometry
- Same temperature profile
- Same atmosphere
- Same humidity



## Forced-flow offers several advantages in the investigation of gas/solid phase reactions

### Patent pending

- 1. Controlled Conditions:** Precise control of reaction conditions for a reproducible environment.
- 2. Faster Reaction Times:** Acceleration of slow reactions through continuous flow.
- 3. Better Mixing:** Uniform distribution of reactants for improved reaction kinetics.
- 4. Continuous Analysis:** Enables real-time monitoring and control of the reaction.
- 5. Scalability:** Easier adaptation to different volumes and flow rates for optimized production.

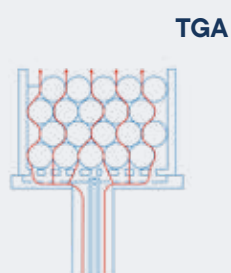
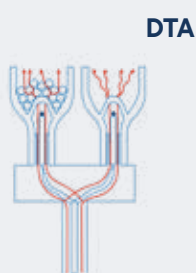
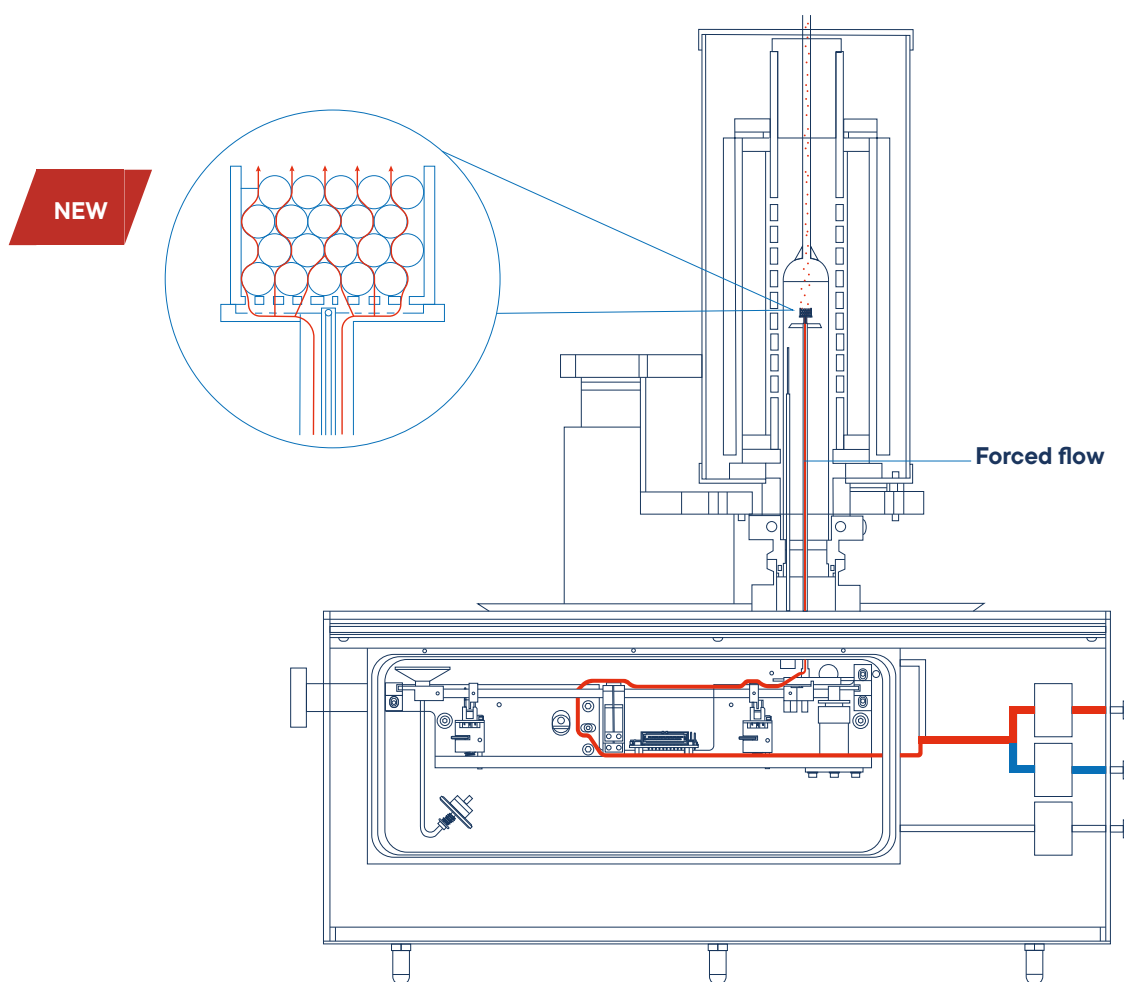

The Forced-Flow principle is available for both, Thermogravimetric Analysis (TGA) and Differential Thermal Analysis (DTA). The Forced-Flow principle extends its capabilities to the fields of thermogravimetry and differential thermal analysis, potentially leading to improved investigative methods and more accurate results.

## Oxidation rates of copper with different gas supplies

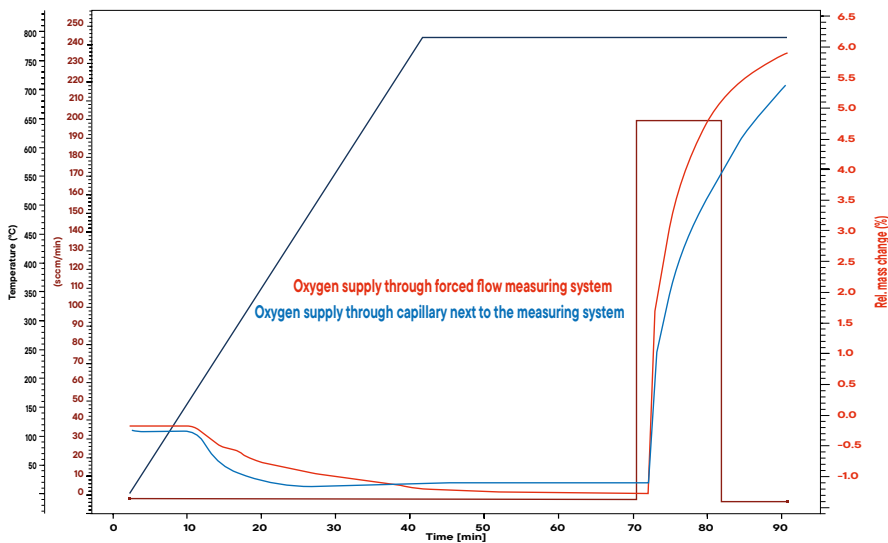

During the oxidation of copper, copper oxide is formed, with reaction speeds depending on the gas supply. The Forced-Flow principle ensures that the gas is quickly and evenly distributed across the entire sample material from the outset. This allows faster reaction rates compared to conventional methods where the gas slowly comes into contact with the sample. The reaction for the formation of copper oxide can be represented as:

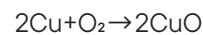

The Forced-Flow principle ensures that the oxidizing agent ( $\text{O}_2$ ) reacts rapidly and efficiently with the copper ( $\text{Cu}$ ), leading to accelerated reaction rates.

Here is a simulated fluidized bed. It is possible to observe the fluidized bed during the reaction using a camera. A fluidized bed is a system where solid particles are kept in motion by a gas stream, enabling intense mixing and efficient reactions. The vigorous movement of the solid material in the fluidized bed reactor ensures uniform distribution and mixing of solid and gas, crucial for efficient chemical reactions.





deliv  
outst

ser



ering

anding

vice

# STA L81

## STA L81/1

The highest resolution 0.025 µg balance for small sample quantities allows the detection of very small effects with highest accuracy.

## STA L81/2

The high mass variant allows measuring samples with big volumes or weight up to 50 g to determine even small effects within a large amount of inhomogeneous material.

## STA L81/3

The standard model (25 g) covers a broad application range with excellent resolution (0.1 µg) and accuracy.

TG - DSC/DTA  
+ Pressure



# Software

All LINSEIS thermo analytical instruments are software controlled. The individual software modules run exclusively under Microsoft® Windows® operating systems. The complete software consists of a data acquisition, data evaluation and administration module and incooperates all essentials: features for measurement preparation, execution and evaluation of a thermoanalytical measurement. Thanks to our specialists and application experts, LINSEIS was able to develop comprehensive, easy to understand, user friendly and application driven software.

## Features-Software:

- Data security in case of power failure
- Thermocouple break protection
- Repetition measurements with minimum parameter input
- Evaluation of current measurement
- Curve comparison of up to 50 curves
- Storage and export of evaluations
- Export and import in ASCII format
- Data export to MS Excel
- Multi-methods analysis (DSC, TG, TMA, DIL, etc.)
- Zoom function
- 1st and 2nd derivation
- Programmable gas control
- Curve arithmetics
- Statistical evaluation package
- Free scaling
- Automatic calibration
- Optional Kinetic and Lifetime Prediction
- Software packages
- Interface to MS and FTIR

## TG – Features:

- Mass change as % and mg
- Rate Controlled Mass Loss (RCML)
- Evaluation of mass loss
- Residue mass evaluation

## HDSC – Features:

- Glass transition temperature
- Complex peak evaluation
- Multipoint calibration for sample temperature
- Multipoint calibration for change of enthalpy
- Cp calibration for heat flow
- Signal-steered measuring procedures

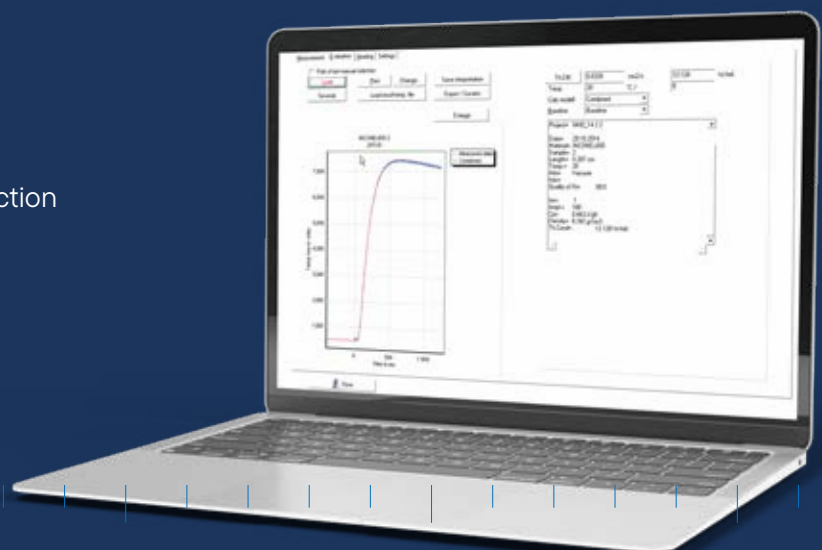

## Thermal Library

The LINSEIS Thermal Library software package comes as an option for the well-known, user friendly LINSEIS LiEAP (Linseis Evaluation and Acquisition Platform) software that is integrated in almost all our instruments. The Thermal Library allows the sample material identification by comparing the measurement curve with a data base providing thousands of references and standard materials within only 1-2 seconds.

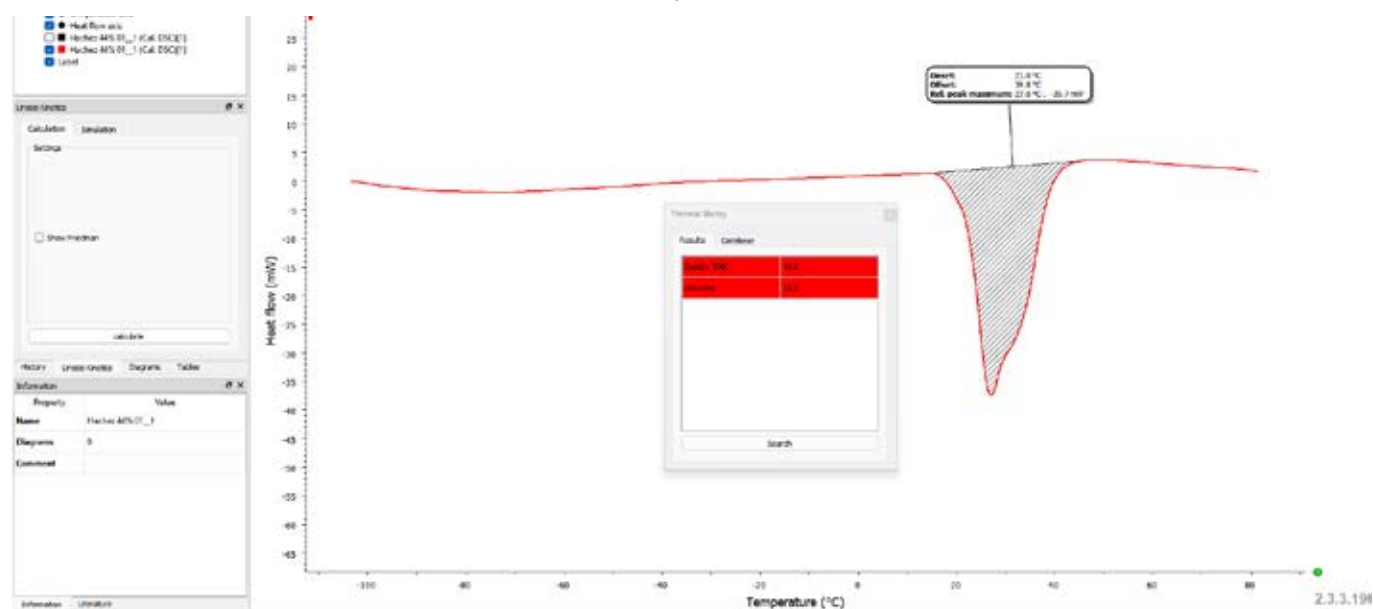

## Multi-Instrument

All LINSEIS instruments DSC, DIL, STA, HFM, LFA, etc. can be controlled with the same powerful LiEAP software platform.

## Report Generator

Convenient template selection to generate customized measurement reports.

## Kinetic software

Kinetic analysis of DSC, DTA, TGA, EGA (TG-MS, TG-FTIR) data for the study of the thermal behavior of raw materials and products.

## Multi-Lingual

Our software is available in many different user exchangeable languages, such as: English, Spanish, French, German, Chinese, Korean, Japanese, etc.

## Multi-User

The administrator can generate different user levels providing different rights to operate the instrument. An optional Log file is also available.

## Database

State of the art database design enables easy data handling, with up to 1000 data sets.



# Technical Specifications

	STA L81		
<b>Temperature range</b>	-150 °C up to 500 / 700 / 1000 °C RT up to 1000 / 1400 / 1600 / 1750 / 2000 / 2400 °C		
<b>Vacuum</b>	10-5 mbar (depends on vacuum pump)		
<b>Pressure</b>	up to 5 bar (optional)		
<b>Heating rate</b>	0.01 up to 100 K/min (depends on furnace) (from 0.001 °C/min on request)		
<b>Temperature precision</b>	0.001 °C		
<b>Sample robot</b>	optional 42		
<b>TG</b>	1	2	3
<b>Resolution</b>	0.01 µg	0.02 µg	0.1 µg
<b>Sample weight</b>	Balance can read weight automatically		
<b>Measuring range</b>	25 g (total) / 2500 mg (mass change)	25 g (total) / 2500 mg (mass change)	35 g (total) / 2500 mg (mass change)
<b>DSC</b>			
<b>DSC-sensors</b>	E / K / S / B / C (C = DTA only)		
<b>DSC resolution</b>	0.3 / 0.4 / 1 / 1.2 µW		
<b>Calorimetric sensitivity</b>	approx. 4 / 6 / 17.6 / 22.5 µW		
<b>DTA</b>			
<b>DTA-resolution</b>	0.03 nV		
<b>Sensitivity</b>	1.5 µV/mW		
<b>DTA-measuring ranges</b>	250 / 2500 µV		



*push  
bound*



# Whining Carries

# Applications STA L81 1600

STA Overview

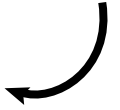

## Decomposition of $\text{CaC}_2\text{O}_4 \cdot \text{H}_2\text{O}$

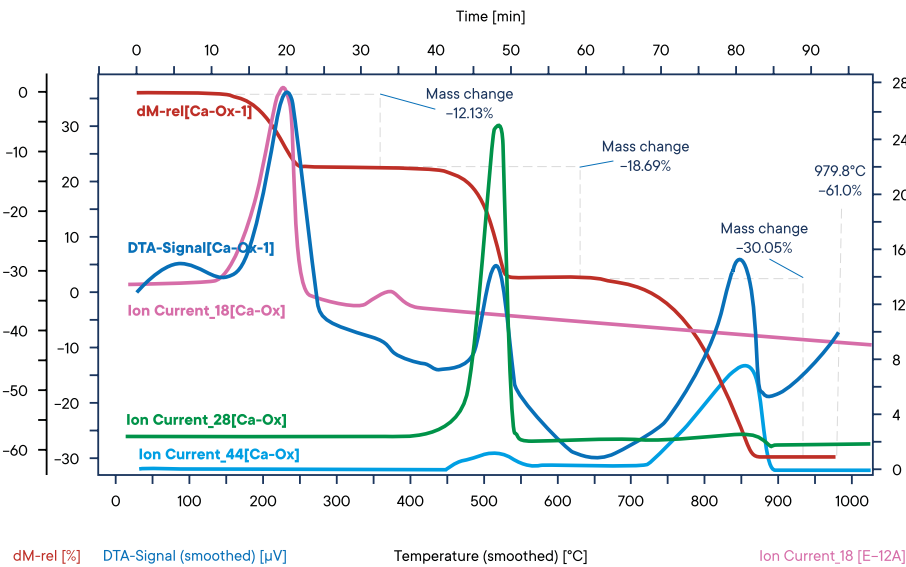

The evolved gases from the decomposition of calcium oxalate has been fed into the mass spectrometer with a heated capillary. The ion currents for mass numbers 18 (water), 28 (carbon monoxide) and 44 (carbon dioxide) have been imported into the graph.

## Cement

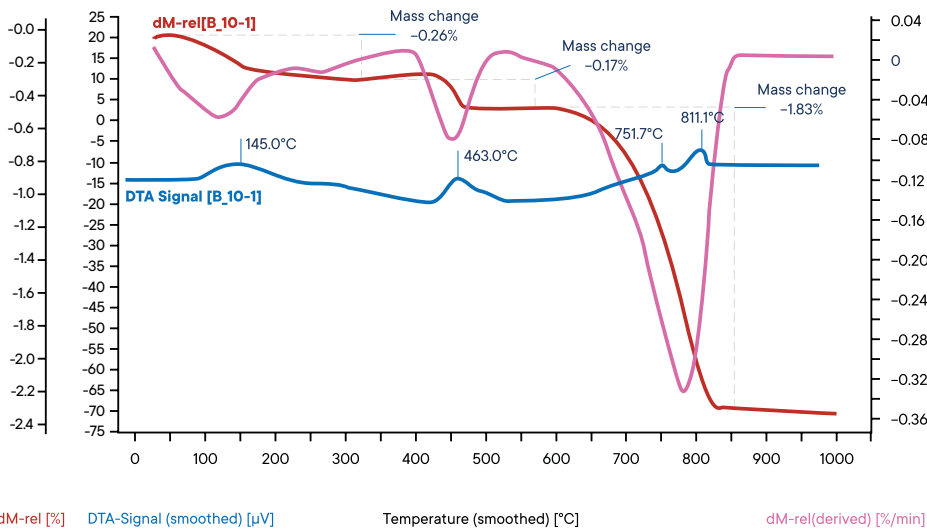

The main parts of cement are tri calcium silicate, di calcium silicate and tri calcium aluminates. Hydrates slowly form after mixing cement with water. The absorbed water evaporates first. Hydrates of the calcium silicate decompose at 570 °C. The hydroxides of calcium, magnesium and aluminum follow. Subsequently, CO<sub>2</sub> splits off from calcium carbonate.

## Gypsum and Quartz

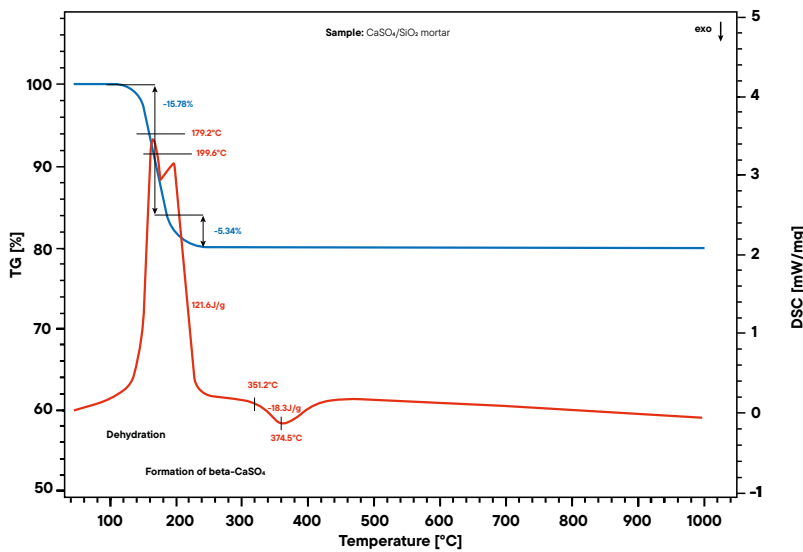

Mortar, made from gypsum and quartz sand, is used to bond bricks and fill holes in buildings. When mixed with water, it forms a paste that hardens into a stone-like material upon drying. This process and the final product can be analyzed through thermal techniques, including Simultaneous Thermal Analysis (STA), to study its decomposition and durability. These insights help understand the material's properties and its behavior under different thermal conditions.

## Thermal decomposition of cement

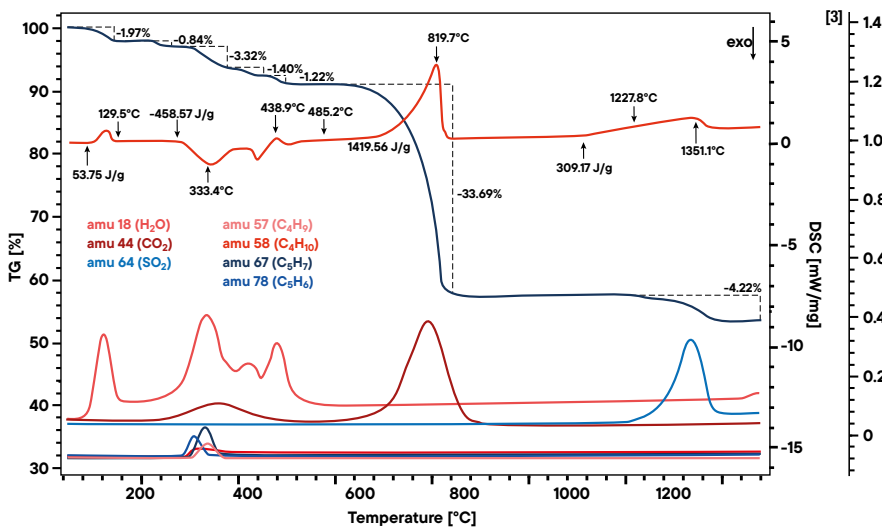

### Analysis using STA and QMS

This application shows STA measurement of cement with coupled MS. Mass spectrometry shows peaks from H<sub>2</sub>O at low temperatures most probably from gypsum. The DSC peaks and the signal from mass spectrometer between ~300°C – 400°C indicates the decomposition of organic components. The peak of CO<sub>2</sub> at ~800°C indicates the decomposition of CaCO<sub>3</sub>. At ~1300°C CaSO<sub>4</sub> decomposes (SO<sub>2</sub> – Peak).



# ***LINSEIS***

*pushing boundaries*

## **LINSEIS GmbH Germany**

Vielitzerstr. 43  
95100 Selb

Tel.: (+49) 9287 880 0  
E-mail: [info@linseis.de](mailto:info@linseis.de)

## **LINSEIS Inc. USA**

109 North Gold Drive  
Robbinsville, NJ 08691

Tel.: (+1) 609 223 2070  
E-mail: [info@linseis.com](mailto:info@linseis.com)

## **LINSEIS China**

Kaige Scientific Park  
Room 120, Building T3, No.1220  
Yuqiao Road, Pudong, Shanghai

Tel.: (+86) 61 90 12 03  
Tel.: (+86) 50 55 06 42  
E-mail: [info@linseis.com.cn](mailto:info@linseis.com.cn)

## **LINSEIS India**

Plot 65, 2nd Floor, Sai Enclave,  
Sector 23, Dwarka05-800  
110077 New Delhi

Tel.: +91-11-42883851  
E-mail: [sales@linseis.in](mailto:sales@linseis.in)



[WWW.LINSEIS.COM](http://WWW.LINSEIS.COM)

10/2024