

LINSEIS

T H E R M A L A N A L Y S I S

DILATOMETRY

DIL L76

DIL L75 Horizontal

DIL L75 Vertical

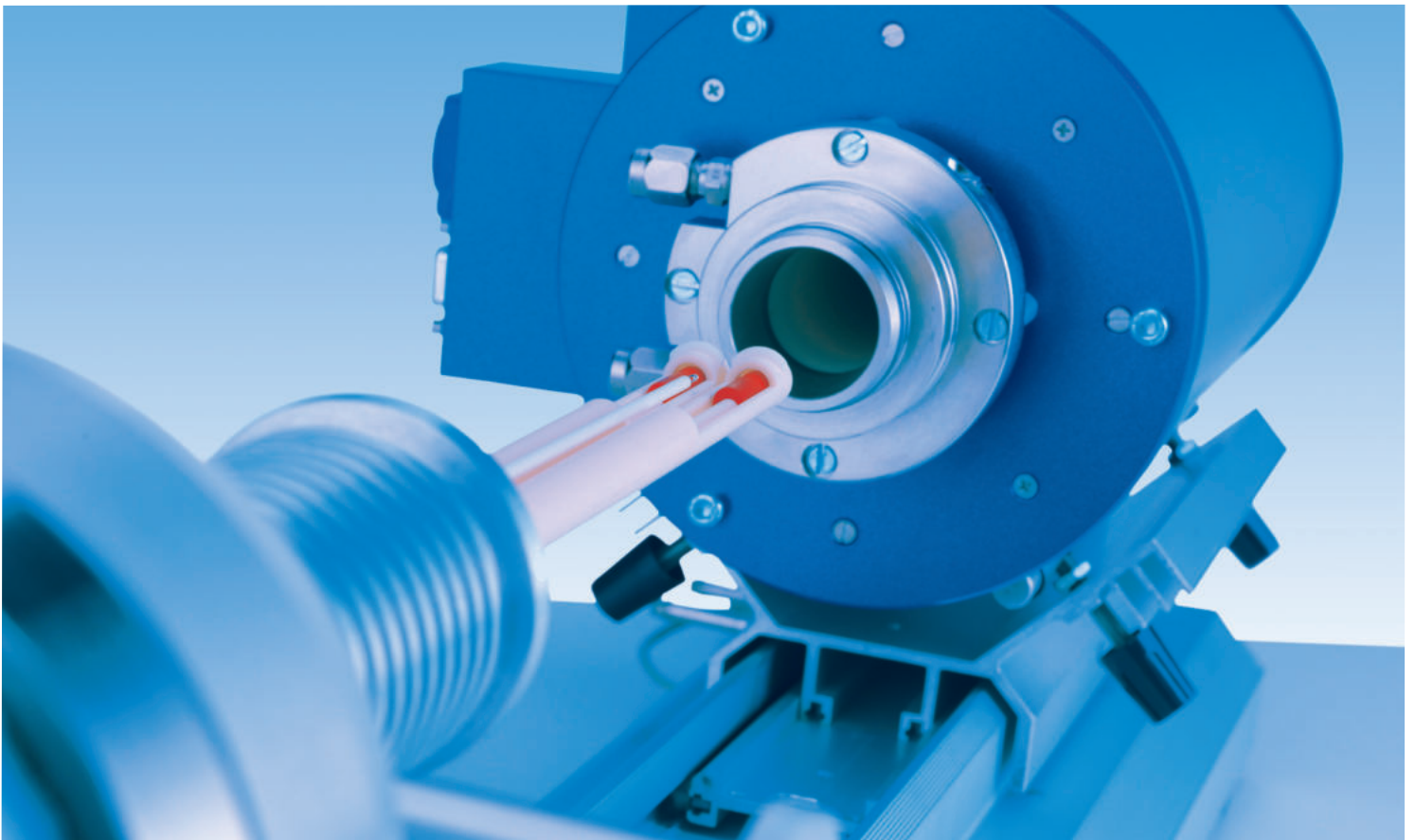

Since 1957 LINSEIS company has been delivering outstanding service, know how and leading innovative products in the field of thermal analysis and thermo physical properties.

Customer satisfaction, innovation, flexibility and high quality are what LINSEIS represents. Thanks to these fundamentals our company enjoys an exceptional reputation among the leading scientific and industrial organizations. LINSEIS has been offering highly innovative benchmark products for many years.

The LINSEIS business unit of thermal analysis is involved in the complete range of thermo analytical equipment for R&D as well as quality control. We support applications in sectors such as polymers, chemical industry, inorganic building materials and environmental analytics. In addition, thermo physical properties of solids, liquids and melts can be analyzed.

LINSEIS provides technological leadership. We develop and manufacture thermo analytic and thermo physical testing equipment to the highest standards and precision. Due to our innovative drive and precision, we are a leading manufacturer of thermal Analysis equipment.

The development of thermo analytical testing machines requires significant research and a high degree of precision. LINSEIS Corp. invests in this research to the benefit of our customers.



Claus Linseis
Managing Director

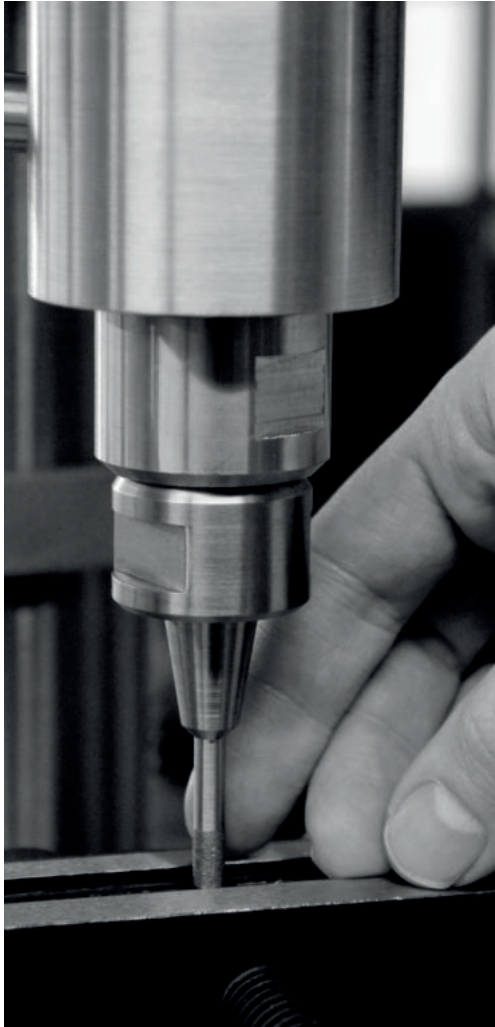

German engineering

The strive for the best due diligence and accountability is part of our DNA. Our history is affected by German engineering and strict quality control.

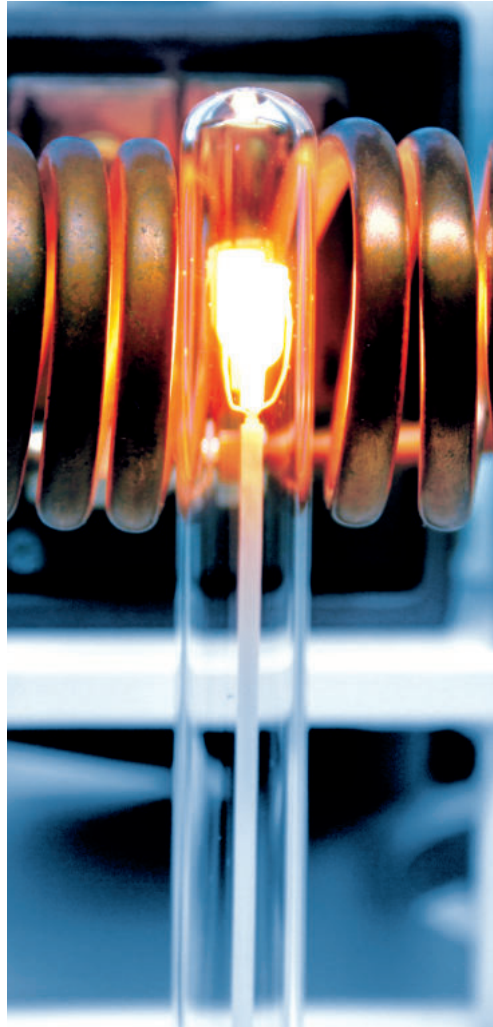

Innovation

We want to deliver the latest and best technology for our customers. LINSEIS continues to innovate and enhance our existing thermal analyzers. Our goal is constantly develop new technologies to enable continued discovery in science.

GENERAL

Dilatometry (DIL) is a technique in which a dimension of a substance (such as: ceramics, glasses, metals, composites, polymers and others) under no or negligible load is measured (e.g. expansion measurement or shrinkage measurement) as a function of temperature while the substance is subjected to a controlled temperature program in a specified atmosphere.

LINSEIS produces a wide range of Single-, Dual-, Differential-, Quattro-, Quenching-, Laser- and Optical Dilatometers in a temperature range from -263°C up to 2800°C and a resolution up to 0.05 nm.

Thanks to our years of experience (est. 1957), Linseis offers Dilatometers with an unbeaten precision variability and performance.

Dilatometers are frequently used for R&D and quality control of solids, liquids, powders and pastes to determine their:

- Determination of thermal expansion coefficient (cte)
- Linear thermal expansion (α)
- Sinter-temperatures and sinter steps
- Determination of glass transition (tg)
- Phase changes
- Optimization of burning processes
- Volume changes
- Rate controlled sintering (rcs)
- Decomposition
- Density change



DIL L75 Vertical

depending on your Application, we offer the perfect solution:

Horizontal Dilatometer L76/L75Horizontal:

- Multipurpose system
- Highest temperature uniformity
- L75h is perfect for research & development

Vertical Dilatometer L75Vertical:

- Friction free sample holder
- Push-rod contact is always guaranteed
- Possible field of application Rate Controlled Sintering (rcs)
- Best arrangement for low -263°C and high temperature up to 2800°C applications

Optical Dilatometer L74 Optical*:

- Non-contact design
- Only choice for melting point determination
- Best choice for rate controlled sintering
- Can be used for additional applications: contact angle determination and heating microscopy
- Best choice for irregularly shaped and soft samples

Quenching and Deformation Dilatometer L78 Q/D/T*:

- Unreached heating and cooling rates ≤ 125 k/s
- Creation of cht/cct/ttt diagrams
- Deformation up to 22 kn

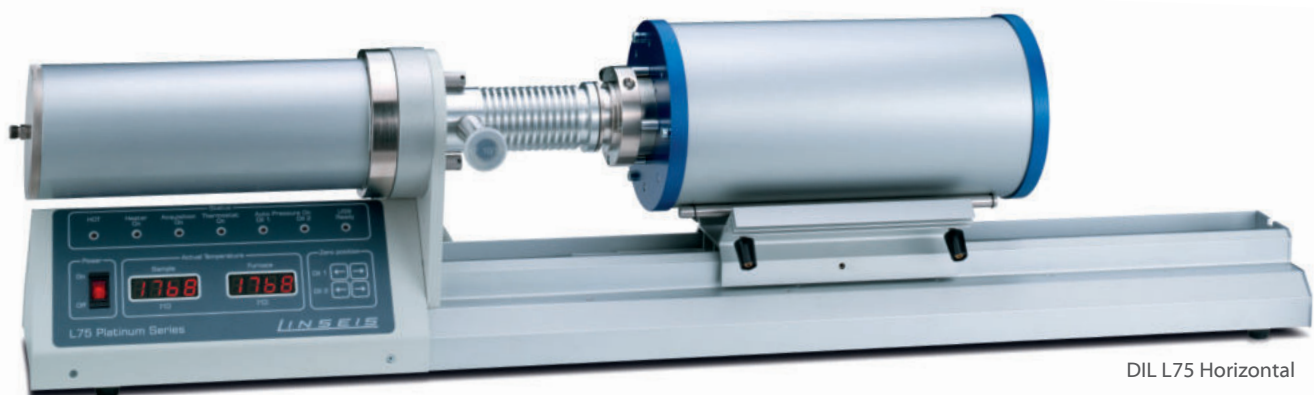

DIL L75 Horizontal

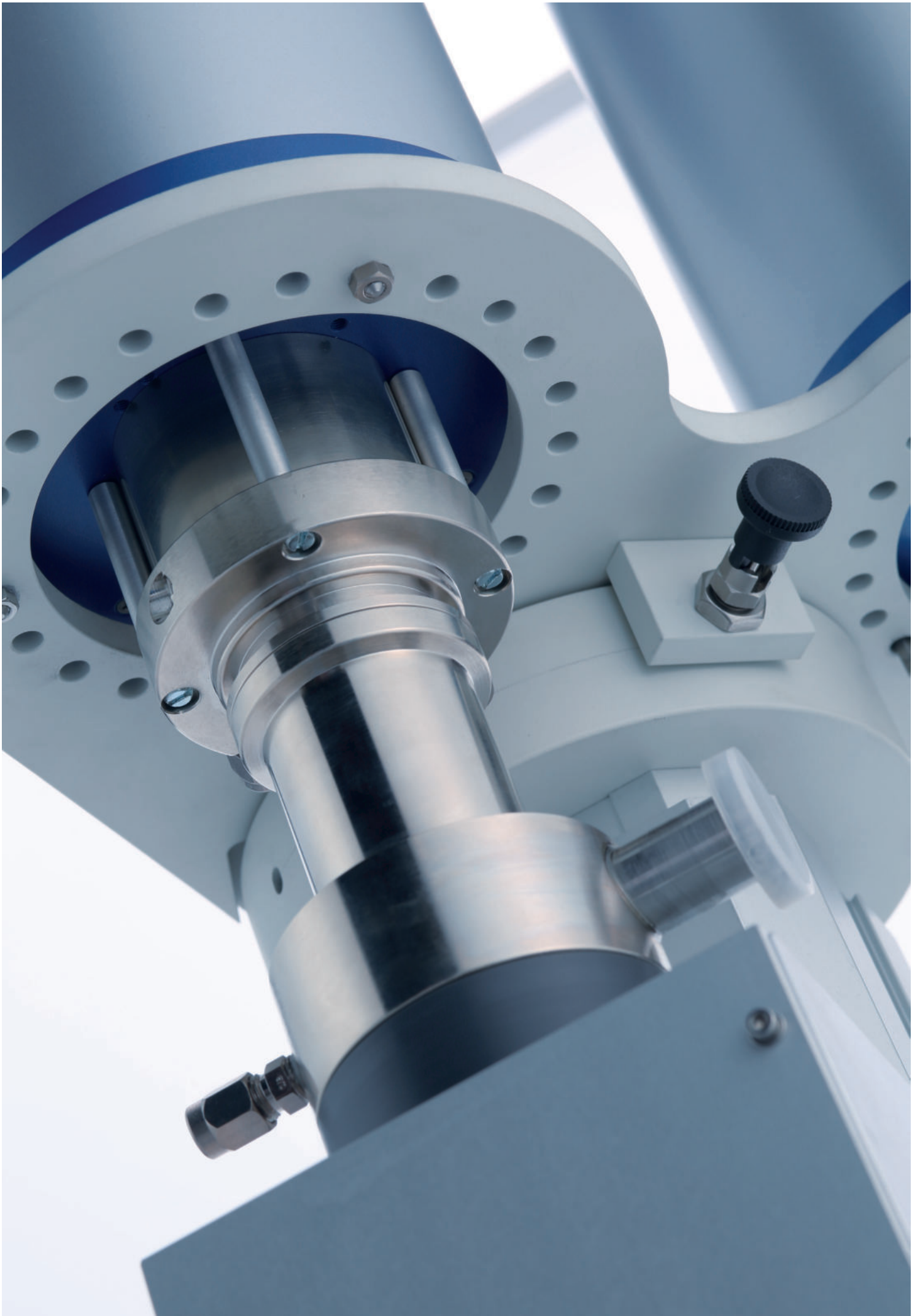

HORIZONTAL VERSUS VERTICAL DILATOMETER

Horizontal arrangement

- Easy and robust design at a modest price
- From -180 to 2800°C. For applications requiring lower or higher temperatures vertical arrangement is better suited.
- Available as single and double arrangement

Vertical arrangement

- Zero friction design (sample is only in contact with the end knob and the pushrod)
- Multi-furnace arrangement (up to three furnaces)...
 - to cover entire temperature range from -263°C to 2800°C
 - to increase throughput (hot furnace can be lifted automatically to switch to new cold furnace and start new measurement)
- Small footprint
- Available as single-, differential/double- and quattro arrangement (1, 2 or 4 samples at the same time)
- Perfect for low temperature measurements (furnace on the bottom - measurement compartment on top) to ensure natural gas path, cold air (falls down) below sensor compartment.
- Perfect for high temperature measurements (furnace on top - measurement compartment below) to ensure natural gas path, hot air (streams up) above sensor compartment.

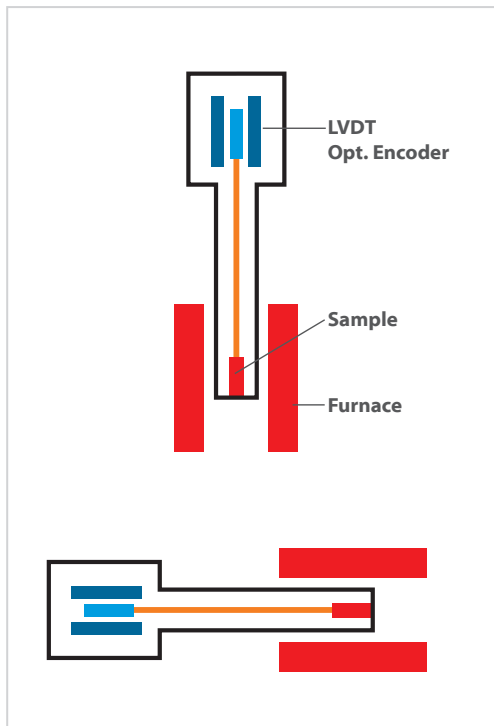

COMPARING LVDT AND LINEAR OPTICAL ENCODER

LVDT

The LVDT (Linear Variable Differential Transformer) consists out of 3 coils, the LVDT body and the movable core. The primary coil is excited by a low frequency AC voltage. The two secondary coils are put in series with reversed polarity. The horizontal position of the core defines the amount of coupling between the primary and the secondary coils. When the core is in the center position, the induced voltages in the secondary coils have the same amplitude. Due

to reversed polarity of the two coils the sum (output voltage) is zero. When the core moves, the coupling between primary and secondary coils changes. So, in one secondary coil the induced voltages increases, while in the other the voltage decreases. So, the sum of both is no longer zero. The sum of amplitude depends on the amount of movement of the core, while the phase (polarity) depends on the direction of the movement.

Advantage:

- The output signal is absolute and unique for each position, no reference movement necessary
- The core can be moved without any friction
- The resolution is infinitive, limited by the noise of the electronics used for signal conditioning
- Not sensitive better suited for applications in dirty environments (gas, vacuum, dust)

Disadvantage:

- Limited measuring range, e.g. +/- 2,5 mm
- Needs calibration

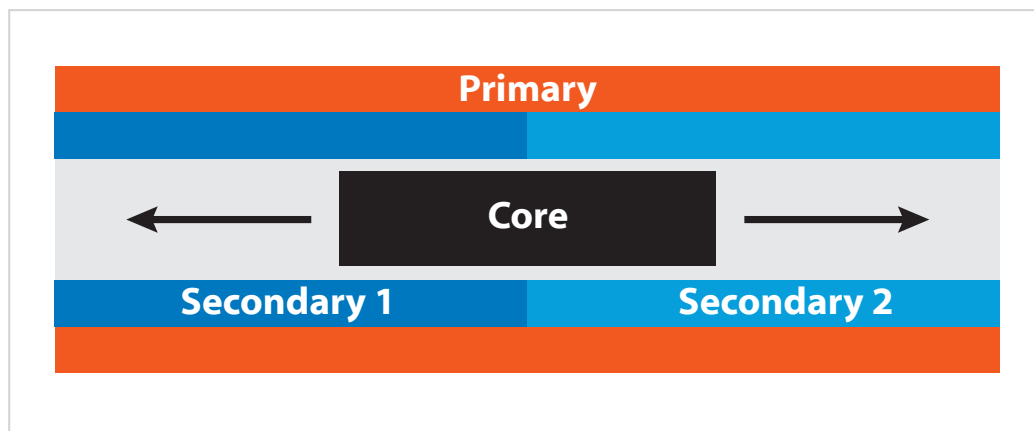

Linear Optical Encoder

A linear optical encoder uses a ruler, made of glass or metal, with a special optical pattern on it. Usually transparent and non-transparent, or reflecting and non-reflecting lines are used. A light source shines to the ruler, and the bright/

dark transitions are measured. The count of measured transitions corresponds to the displacement, while the phase contribution of the two detectors A and B depends on the direction of the movement.

Advantage:

- No calibration necessary
- No limit of measuring range
- Force modulation – offering tma capabilities
- Superior reproducibility

Disadvantage:

- The position change is measured relative, a zero position measurement for absolute position reading is necessary
- Limited resolution: the lower limit for the distance of the patterns on the ruler is app. 20nm. For higher resolutions the reading must be interpolated
- The optical detector system is sensitive to dust (production environment)

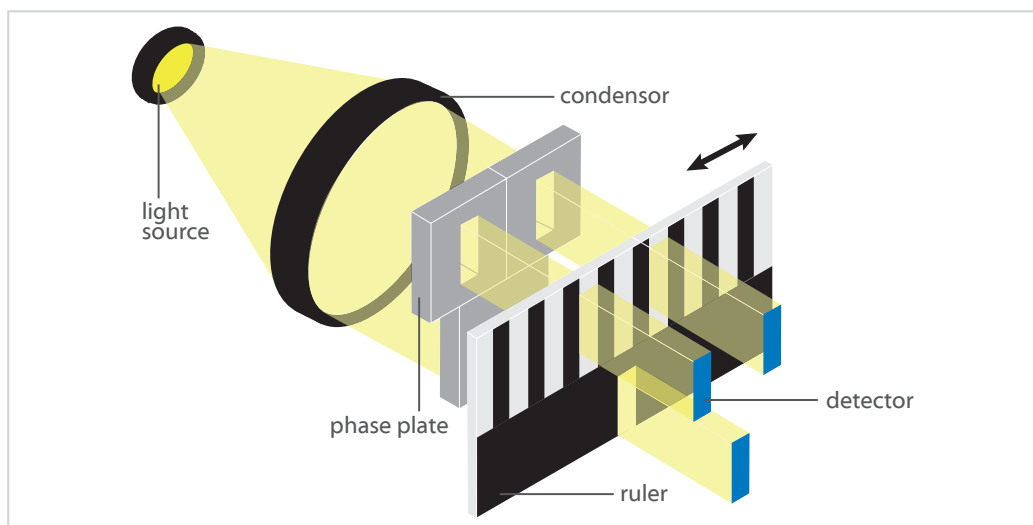

FEATURES

Exciting new features to simplify work

Measuring systems

Numerous different single, double or quattro measuring systems made of fused silica, Al_2O_3 or graphite are available.

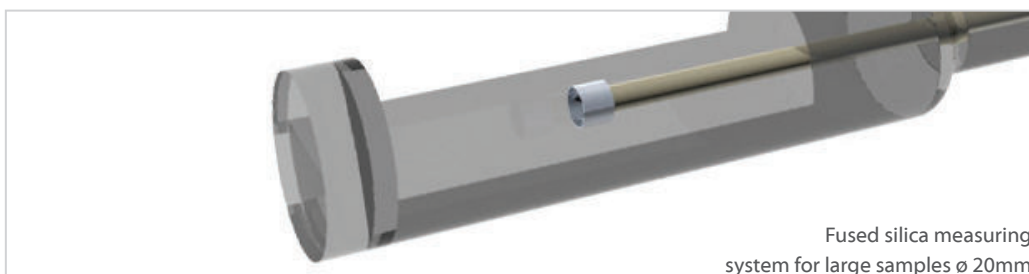
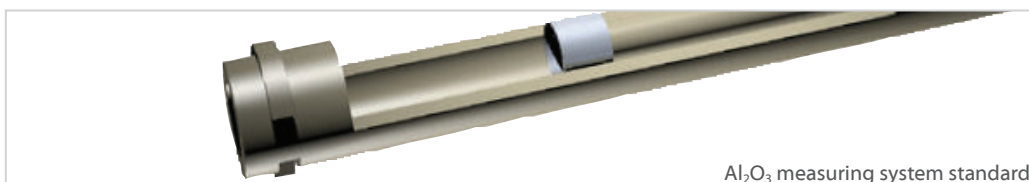

Instrument design

Optimum sensor selection to ensure best measurement result for any given requirement. Integrates Mass Flow Controllers or gas dosing system. Thermostatically controlled measuring compartment disables environmental measurement influences.

MultiNudge

Our sample positioning feature ensures an optimum sample alignment. As the sample piston touches the sample several times it improves the orientation of the sample which is utmost

important for a successful dilatometer measurement.

Automatic Contact Force Adjustment

When it comes to samples with large expansion or soft pressure sensitive samples a contact force adjustment during the measurement is critical to ensure excellent measuring results. This feature eliminates the influence of varying force during the measurement.

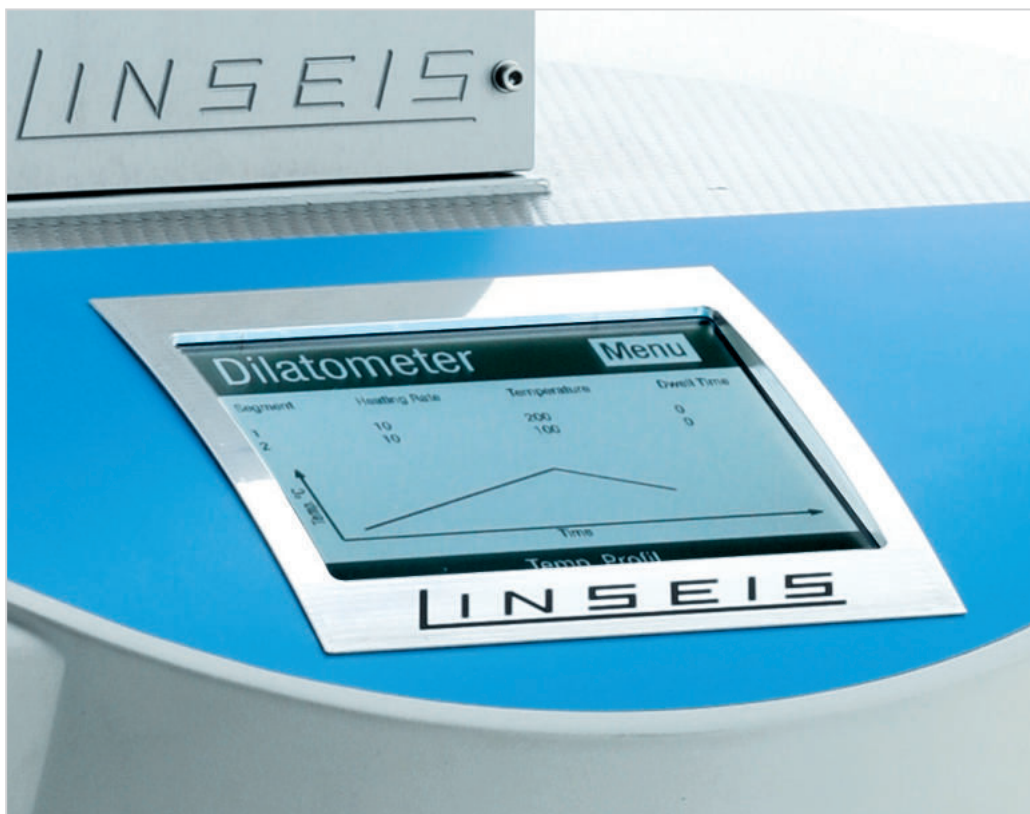

Vacuum and controlled atmosphere

The instrument design provide for high vacuum and inert, reducing, oxidizing or humidified atmosphere. Furthermore, the instrument can be pressurized up to 5 bar overpressure (option). Measurements can be done under corrosive conditions if proper conditions are respected. Residual gas analysis systems can be coupled via an optional heated capillary.

Evolved gas analysis

Optional gas analysis with MS, FTIR or GCMS is possible. This provides valuable additional information of the sample composition.

Wide temperature range -263°C to 2800°C

The LINSEIS Dilatometers can be equipped with up to three furnaces at the same time. A broad variety of different furnaces is available to enable measurements in the widest temperature range on the market.

Starter kit

The starter kit includes a variety of tools such as scissors, cutting tools, anti-electrostatic tweezers, magnifier, crucible holder, pipette, rasps, spatula etc.



CUSTOMIZED DILATOMETERS

Dilatometer with electrical ports for Piezo elements

Piezo elements are semiconductors that change their mechanical properties if they are connected to a voltage. Depending on intensity and direction of voltage, piezo actors typically shrink or expand. They can be used as mechanical switches in valves or as a fuse for instance. Using a special Linseis L75 pushrod dilatometer, their behavior can be studied over temperature and vs voltage. Therefore, a standard dilatometer was modified by removing the vacuum pump and attaching electrodes through the vacuum connector into the sample chamber. The cables can then be attached to a power generator that can be controlled by software, while the sample is placed in a special sample holder at the normal sample position. The expansion and shrinkage of the piezo sample can then be measured depending on the given voltage at any temperature.

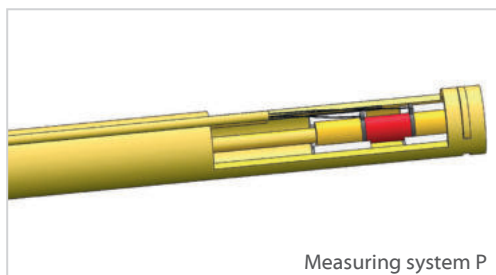

Macro-Dilatometer for huge samples

The macro-dilatometer was developed out of a classic Linseis L75 horizontal pushrod-dilatometer to be able to measure samples that exceed the standard sample size. In the example below, a company who is developing casting molds for steel industry wanted to simulate the burning process of their molds by heating them to target temperature immediately. As they need a certain amount of material to get correct data, the samples were around 3-4 cm diameter which is way more than a classic dilatometer sample would be. In the given example, the furnace was able to be heated to target temperature of 1000°C before the measurement system was inserted – like in the burning process of the mold, where the cold parts are moved into a hot furnace. The measurement starts before the sample sees the heat, allowing to measure the rapid sintering when it is moved into the furnace.

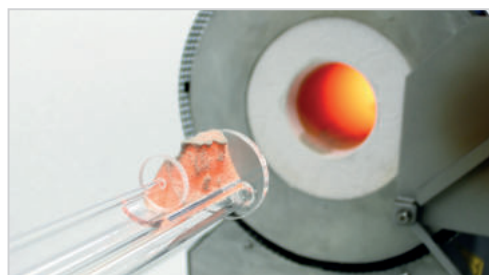

SOFTWARE

All LINSEIS thermo analytical instruments are PC controlled. The individual software modules exclusively run under Microsoft® Windows® operating systems.

The complete software consists of 3 modules: temperature control, data acquisition and data evaluation. The software incorporates all essential features for measurement preparation, execution, and evaluation of a dilatometer run.

Thanks to our specialists and application experts, LINSEIS offers comprehensive easy to understand user friendly application software.

Software-Features:

- Program capable of text editing
- Data security in case of power failure
- Thermocouple break detection
- Repetition measurements with minimum parameter input
- Evaluation of current measurement
- Curve comparison

Software

- Storage and export of evaluations
- Export and import of data ASCII
- Data export to MS Excel
- Multi-methods analysis (DSC, TG, TMA, DIL, etc.)
- Zoom function

- 1st and 2nd derivative
- Programmable gas control
- Statistical evaluation package
- Automatic axis re-scaling
- Softening point detection

DIL Features:

- Rate Controlled Sintering (RCS) software
- Interchangeable thermocouples for various atmospheres
- Sinter process evaluation
- Glass transition and softening point evaluation
- Softening point determination and system shut down
- Linear thermal expansion evaluation
- Several system correction features
- Automatic zero point adjustment
- Auto-scheduler for up to 16 sub-sequent runs

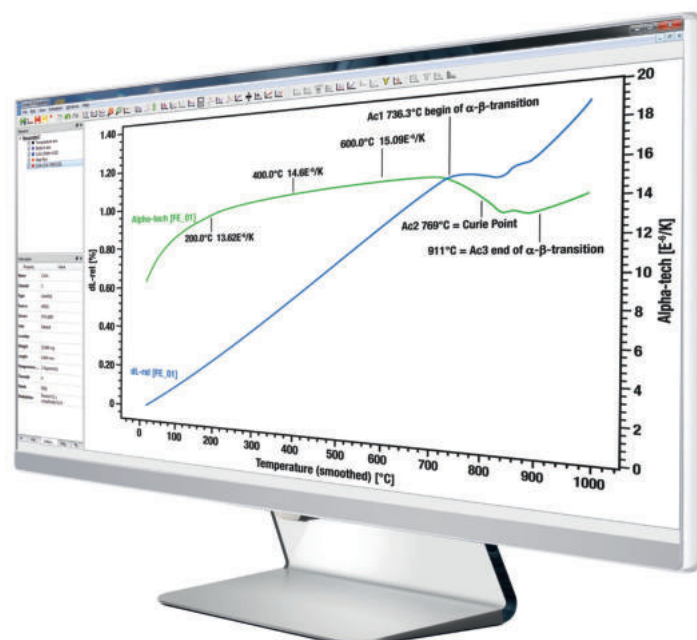

Thermal Library

The LINSEIS thermal library software package comes as an option for the well-known, user friendly LINSEIS Platinum evaluation software, that is integrated in almost all our instruments.

The thermal library allows for the comparison of the complete curves with a data base providing thousands of references and standard materials within only 1-2 seconds.

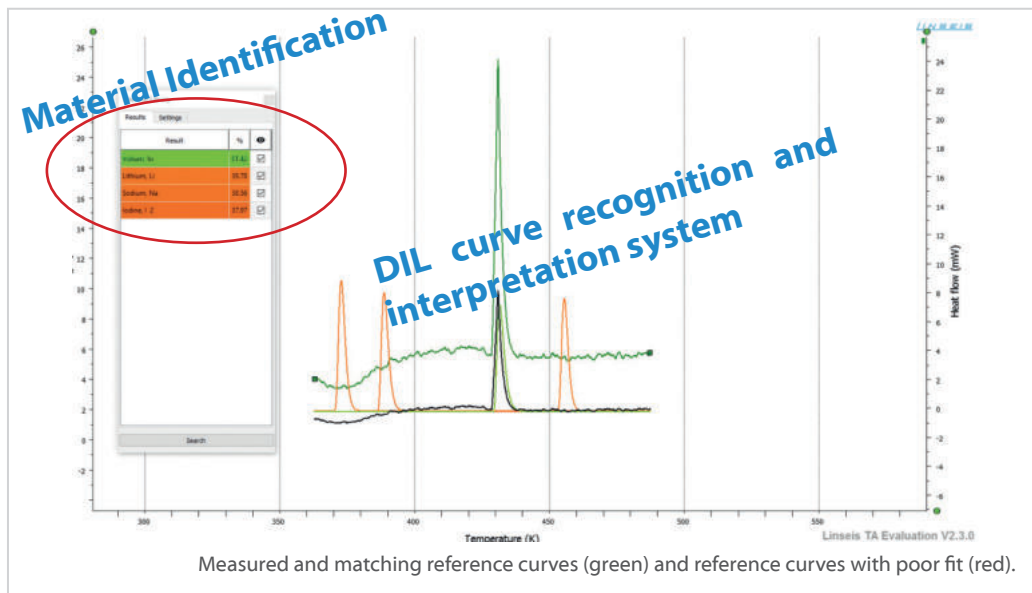

Multi-Instrument

All LINSEIS instruments DIL, TMA, DSC, DTA, TGA, STA etc. can be controlled from one software template.

Multi-User

The administrator can generate different user levels providing different rights to operate the instrument. An optional log file is also available.

Report Generator

Convenient template selection to generate customized measurement reports.

Kinetic software

Kinetic analysis of DIL, TMA, DSC, DTA, TGA, STA etc. data for the study of the thermal behavior of raw materials and products.

Multi-Lingual

Our software is available in many different user exchangeable languages, such as: English, Spanish, French, German, Chinese, Korean, Japanese, etc.

Data Base

Physical constants of new materials can be easily integrated by the user.

SPECIFICATIONS

	L76	L75 Horizontal	L75 Vertical
Temperature range	RT up to 1600°C	-180 up to 2800°C	-263 up to 2800°C
Delta L resolution	0.05 nm	0.03 nm	0.03 nm
Measuring range	±2500 µm	±2500 µm	±2500 µm
Contact force	—	10 mN up to 1N	10 mN up to 1N
Delta L resolution	1 nm	0.1 nm	0.1 nm
Measuring range	±25000 µm	±25000 µm	±25000 µm
Automatic sample length detection	yes	yes	yes
Force modulation	no	yes	yes
Contact force	50 mN up to 3 N	10 mN up to 5 N	10 mN up to 5 N
Heating rates	Based on furnace: • steel, copper, fused silica, silicon carbide: 0.001 up to 50 K/min • graphite 0.001 up to 100 K/min		
Sample holder	user interchangeable, SiO ₂ , Al ₂ O ₃ , graphite All sample holders available as: • single sytem (one pushrod) • system with two pushrods • Al ₂ O ₃ sample holder Fused silica and Al ₂ O ₃ sample holders available as hollow tubes or massive rods		
Temperature /Accuracy / Precision / Resolution	1 K / 0.1 K / 0.001 K	1 K / 0.1 K / 0.001 K	1 K / 0.1 K / 0.001 K
Thermal stability (isotherm)	± 0.02 K	± 0.02 K	± 0.02 K
ΔL / L₀ Repeatability	0.001%	0.001%	0.001%
ΔL / L₀ Accuracy	0.002%	0.002%	0.002%
Force resolution	—	0.001 mN	0.001 mN
Gas atmosphere	Inert, oxid., red.	Inert, oxid., red., vac.	Inert, oxid., red., vac.
Software	latest Windows operating system older versions possible on request		

LVDT

Optical Encoder

FURNACES

Temperature	Type	Heating element	Atmosphere	Temperature sensor
-263°C – 300°C	L75/264 He	Thermo coax	inert, oxid., red., vac.	Semiconductor / PT 100
-180°C – 500°C	L75/264	Thermo coax	inert, oxid., red., vac.	Type K
-180°C – 700°C	L75/264/700	Thermo coax	inert, oxid., red., vac.	Type K
-180°C up to 1000	L75/264/1000	Thermo coax	inert, oxid., red., vac.	Type K
RT – 1000°C	L75/220	Kanthal	inert, oxid., red., vac.	Type K
RT – 1400°C	L75/230	Kanthal	inert, oxid., red., vac.	Type S
RT – 1600°C	L75/240	SiC	inert, oxid., red., vac.	Type S
RT – 1650°C	L75/240 PT	Platinum	inert, oxid., red., vac.	Type S
RT – 1750°C	L75/240 M	MoSi ₂	inert, oxid., red., vac.	Type B
RT – 2000°C	L75/260	Graphite	N ₂ /Vac.	Type C and/or pyrometer
RT – 2400°C	L75/270	Graphite	N ₂ /Vac.	Pyrometer
RT – 2800°C	L75/280	Graphite	N ₂ /Vac.	Pyrometer

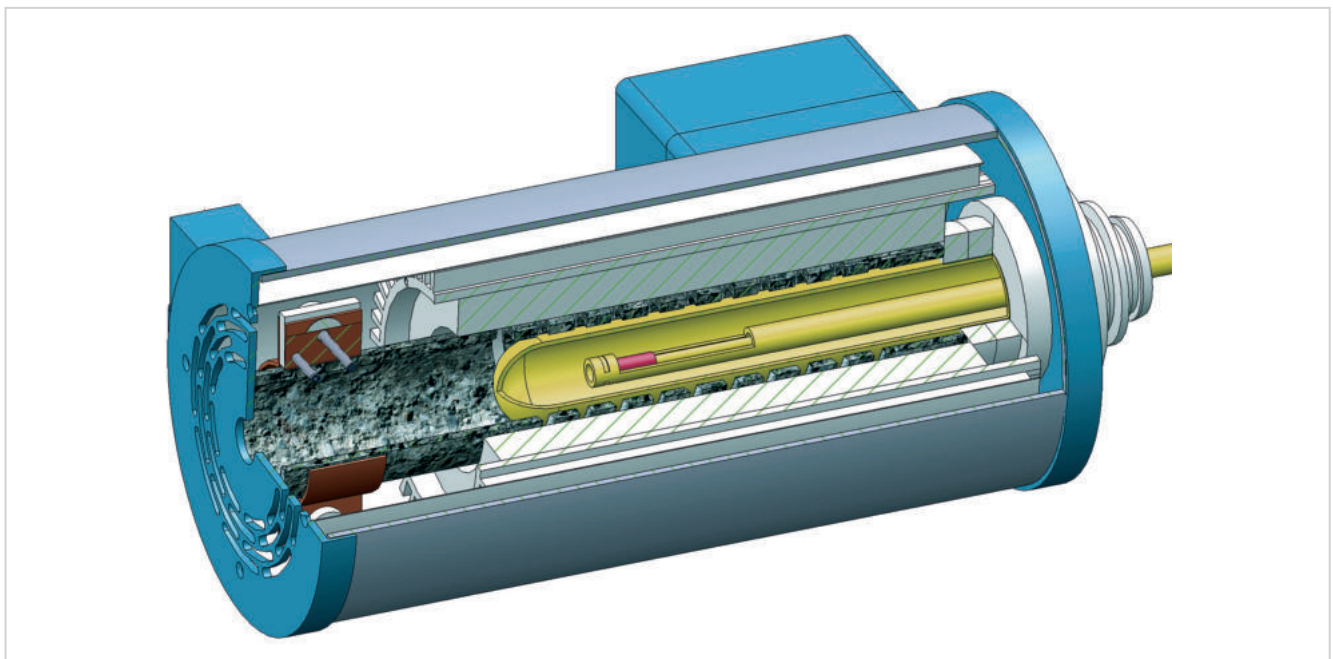

Linseis equipment for operation under water vapor and relative humidity



For many applications in thermal analysis, the atmosphere plays an important role as it may affect the sample behavior or activate reactions. Humidity influence on building materials, storage time of pharmaceuticals and foods or influence on mechanical properties of polymers are just some of the most common examples. Of course, the Linseis instruments are suitable

for such experiments, however there is one fact that is often causing confusion and must be considered carefully: **The difference between water vapor and relative humidity. Relative Humidity Generators (Fig. 1) are most commonly used for experiments around room temperature, while water vapor applications are most often at higher temperatures.**

Difference between water vapor and relative humidity

When water is heated to its boiling point or higher than that, the water changes its aggregate form from liquid to gaseous. It is then existing as water vapor (steam). If this steam is introduced into any kind of reaction chamber or instrument, it is called **water vapor application**. In contrast, every gas can transport and contain

a certain amount of water at a given temperature. **This is called humidity**. Considering air as an example, there is always an amount of water contained in the air, even below the boiling point of water, which is defined as grade of humidity or relative humidity. In the following chapters, the difference shall be shown:

Equipment for hydrogen control and safety

Linseis instruments are all designed for being used in hydrogen atmosphere with just a few adjustments.

The most important thing is a safety system that can ensure that there is no leakage and no explosive atmosphere is generated outside of the instrument. Therefore, the Linseis safety system uses hydrogen sensors that are coupled to an automatic gas control panel. If there is a leakage or unwanted hydrogen release, the instrument is automatically flooded with inert gas and the hydrogen valves are closed. This ensures a minimum risk level during operation. Besides that, the system contains a burn off unit where the gas outlet is connected to, to ensure that also the

used gas of the measurement chamber is not just released into the environment. The system can also be operated with several gas combinations of inert gases and even water vapor besides hydrogen.

In summary, the Linseis H₂ control / safety system comes with the following benefits:

- Automatic evacuation function
- Gas flow control for multiple gases including water vapor and hydrogen
- Emergency shutdown function
- Hydrogen detector system
- Burn off unit

Simultaneous TGA-DTA/DSC measures both, heat flow and weight change of a sample as a function of temperature or time under controlled atmosphere. Simultaneous measurement of these two material properties not only improves productivity but also simplifies interpretation of the results.

The complimentary information obtained allows differentiation between endothermic and exothermic events which have no associated weight change (e.g., melting and crystallization) and those which involve a weight change (e.g., degradation).



APPLICATIONS

Glass Ceramic

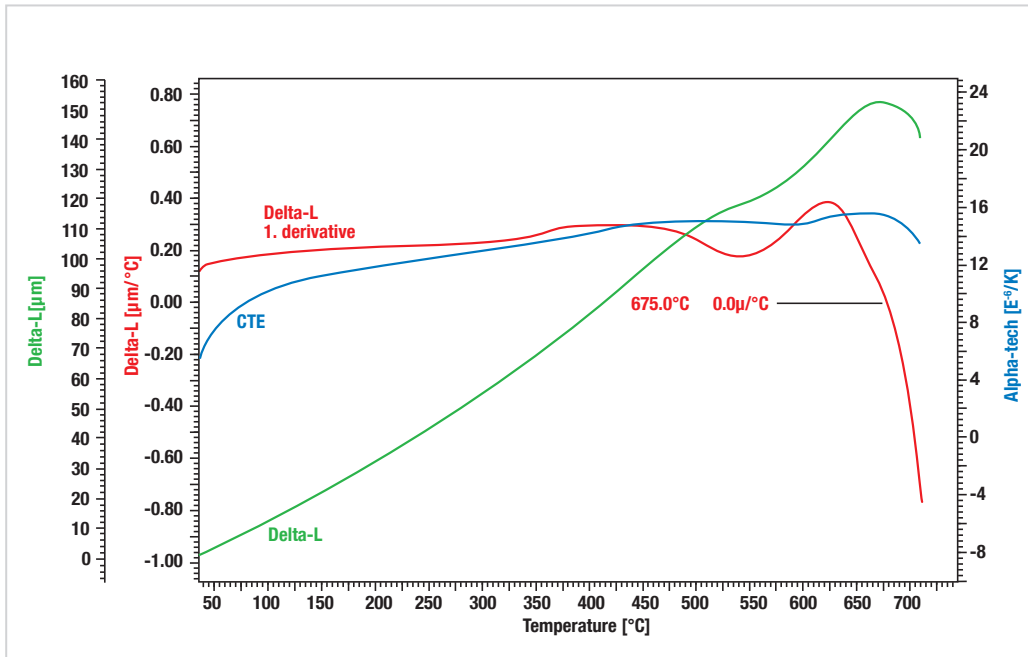

The dilatometric method is an excellent method to determine the thermal expansion (CTE) and the softening point of glass ceramic materials. Besides the absolute expansion and the expansion coefficient (CTE), you can find the first derivative of the absolute expansion. The temperature at which the derivate becomes zero corresponds to the maximum length of the sample and to the softening point of the material.

Iron

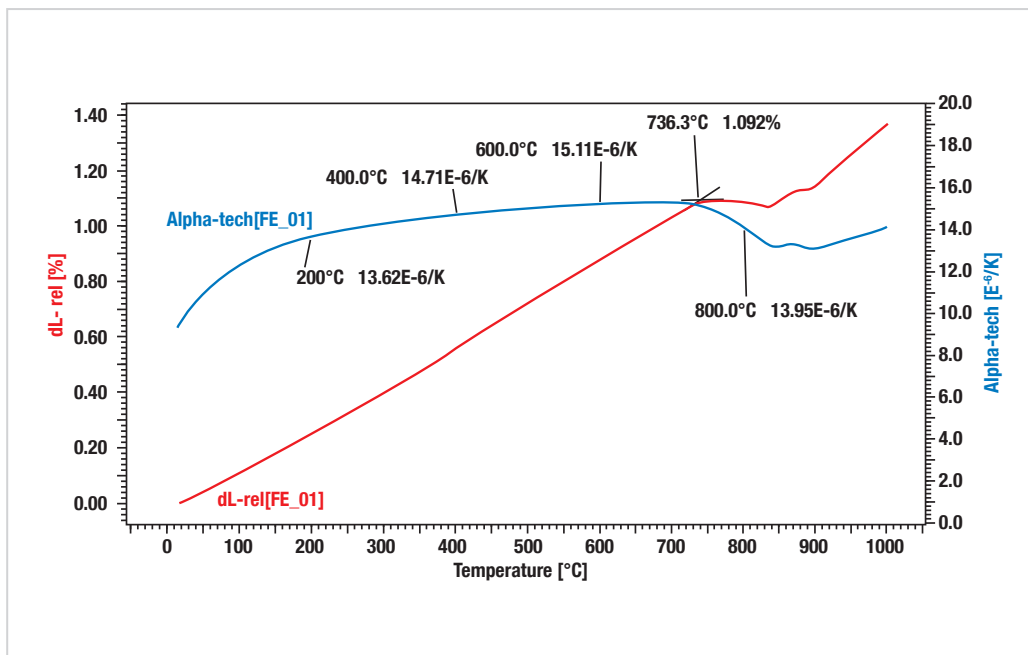

The linear thermal expansion (ΔL) and the CTE of the iron sample under argon atmosphere are evaluated. The heating rate was 5 K/min. Above 736.3°C (maximum temperature of CTE) shrinkage was detected, which is due to a change in the atomic structure, known as the Curie-point. The difference of measured and literature value can be attributed to contamination of the sample.

DTA - Feature

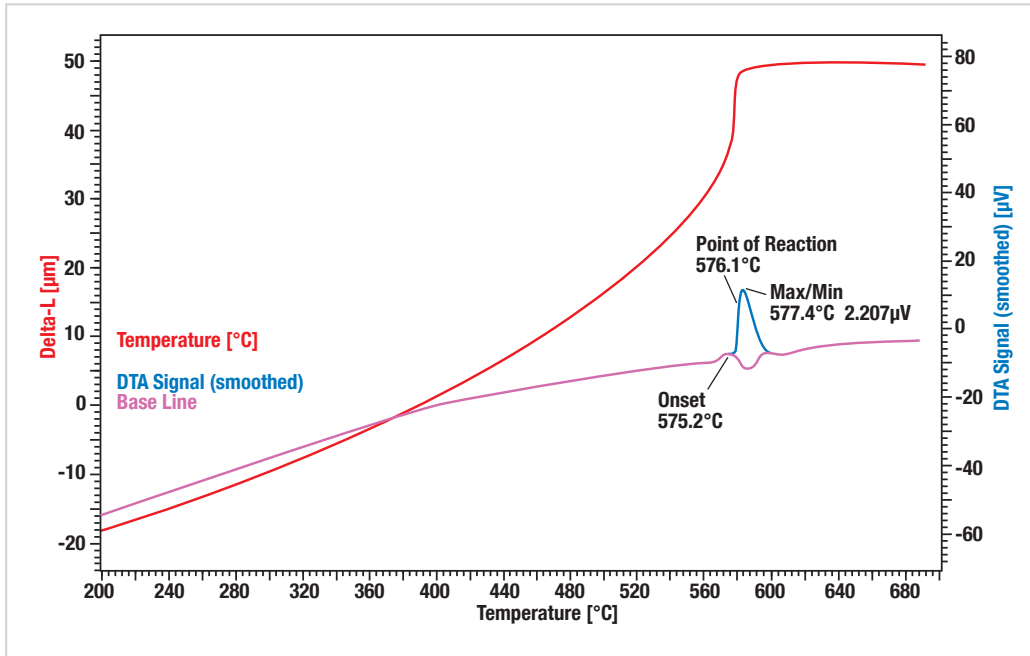

The thermal expansion of α -SiO₂ can be easily evaluated with the L75 Dilatometer. The additional DTA feature enables an in depth view of the thermal behavior of the material. The DTA measurement is a mathematical routine based on the sample temperature. Exo- and endothermic effects influence the change of the sample temperature during the dynamic heating or cooling cycle. The phase transition from α - to β -SiO₂ takes place at app. 575°C. The deviation of the measured temperature from the literature value (574°C) can be used for a temperature calibration.

Glass Sample, softening point

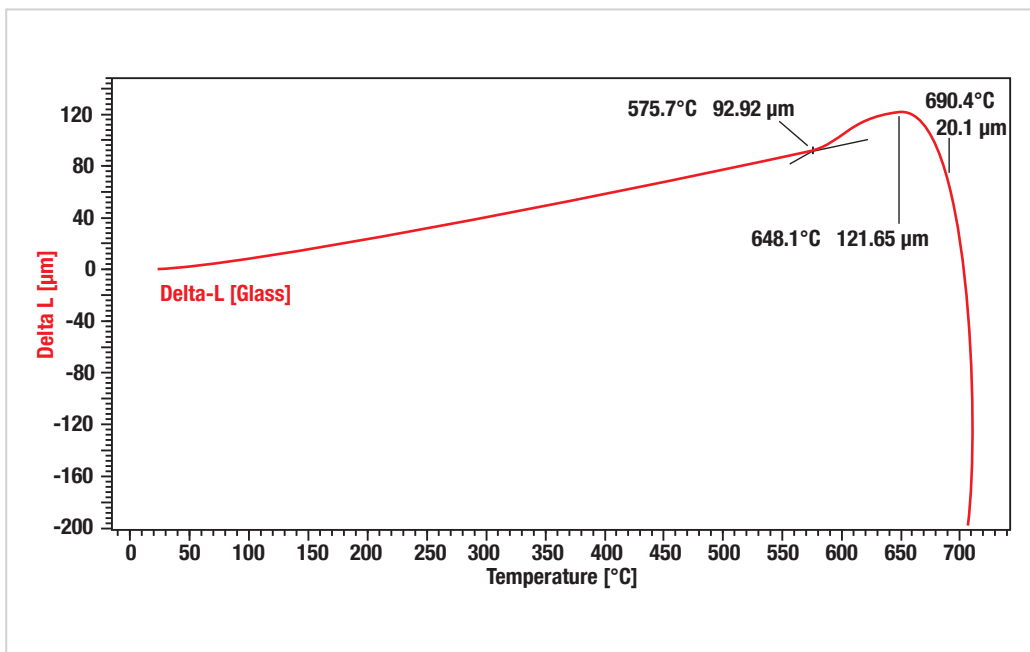

The glass sample was measured using the softening-detection feature. The heating step will be stopped by the software either if the target temperature is reached or if a shrinkage above a pre-defined threshold is detected. In this example, the threshold was set to -100µm meaning that in case that the sample length falls by more than 100 µm below the maximum length of the sample, the heating was interrupted and a cooling segment was started automatically. The softening point can be detected in an easy and safe procedure. The automatic stop of the heating avoids damages on the instruments due to sticking of the sample on the measuring system.

Ceramics / Powder metallurgy

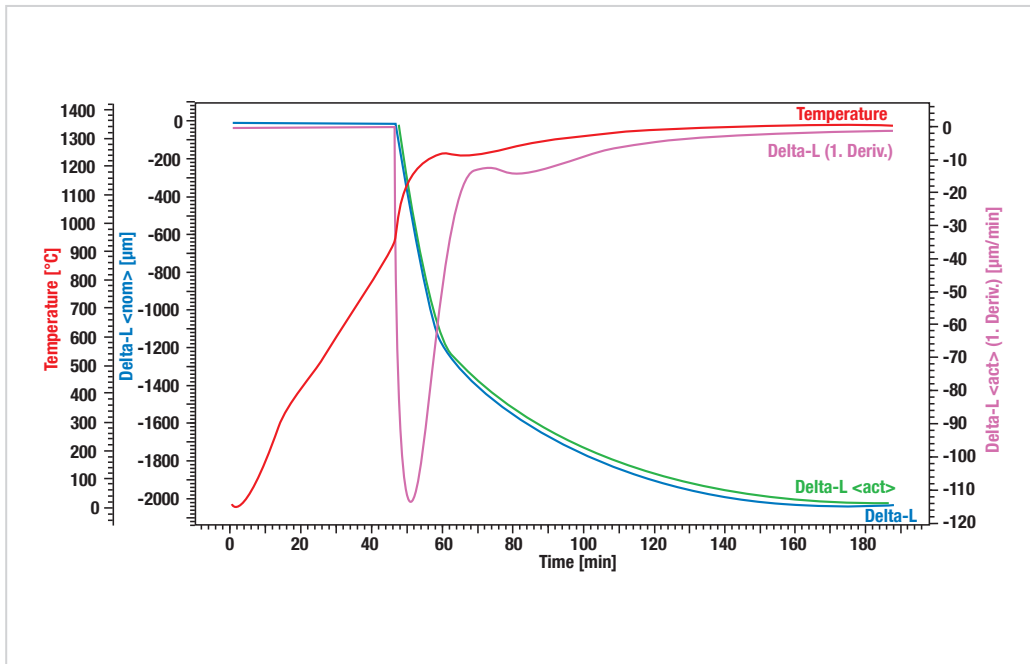

In production processes of high-tech ceramics a simulation of sinter processes is of high interest. When using the optional software package RCS (Rate Controlled Sintering) it is possible to program controlled sintering with a dilatometer as per PALMOUR III theory. The following application is a sintering process of ZrO_2 . After approximately 60 minutes the main sintering step is finished and the heating rate can be slowed down. After approximately 160 minutes the final density of the material is reached and sintering finished.

Copper

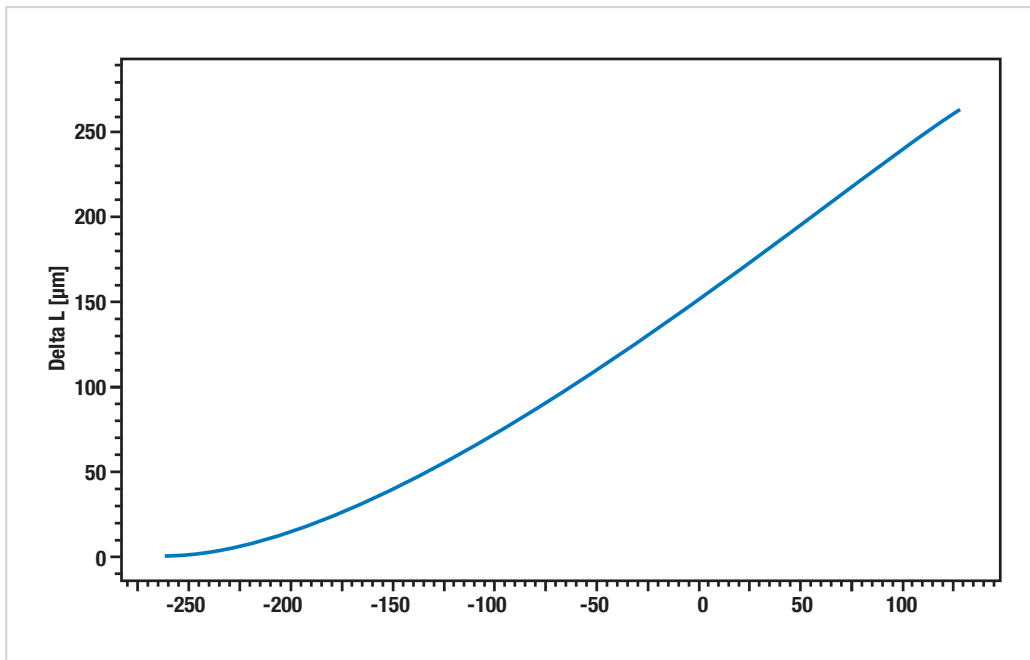

Expansion measurement of copper down to a temperature of 10 K using a Helium cryostat.

ALTERNATIVE DILATOMETERS

Optical versus Pushrod-Dilatometer

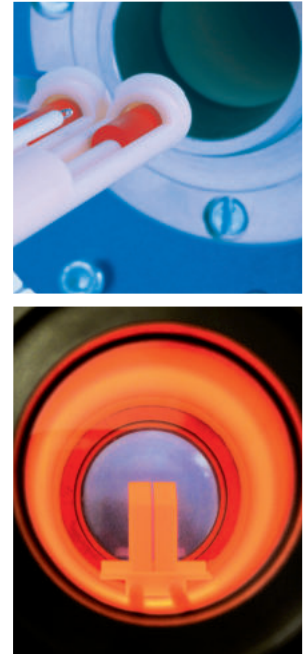
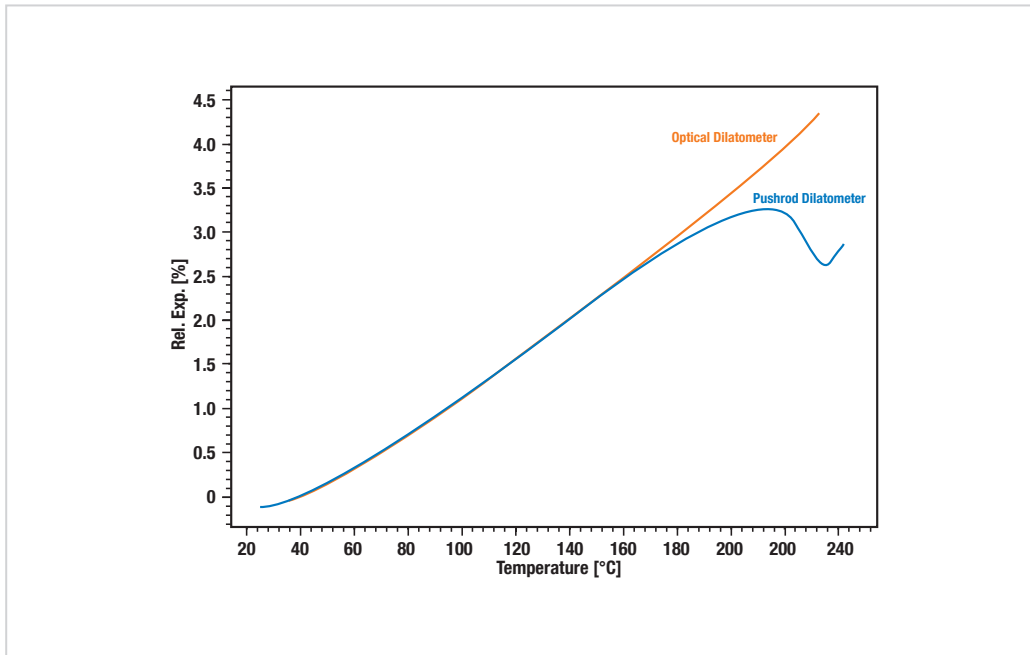

Determination of CCT with RITA Dilatometer

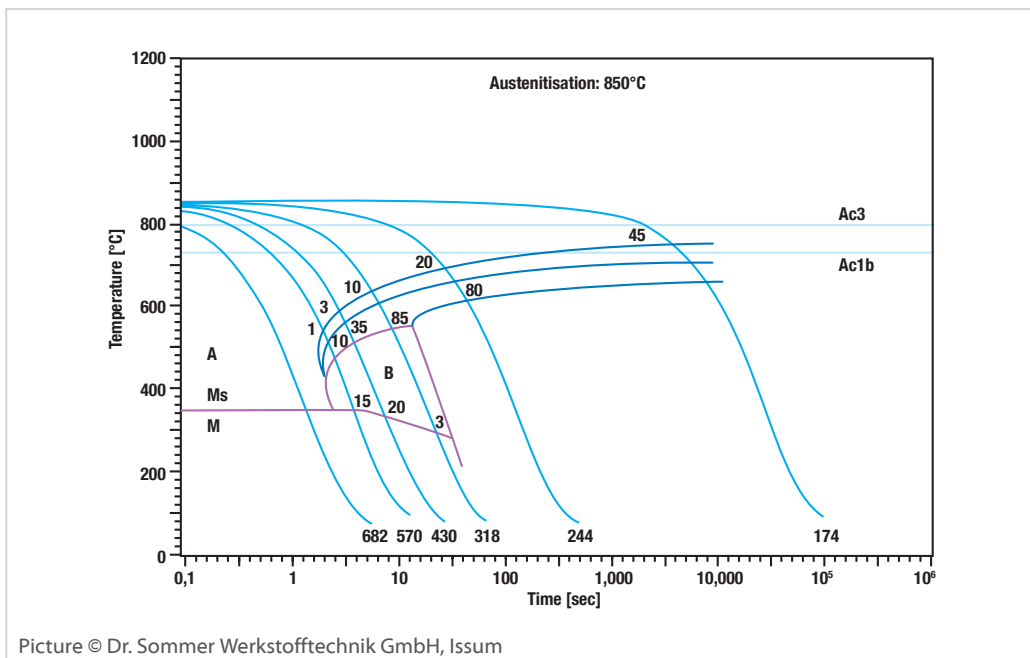

Picture © Dr. Sommer Werkstofftechnik GmbH, Issum

The inductive heating method of the LINSEIS RITA Dilatometer allows the usage of very fast heating and cooling rates. One steel sample like the stainless steel in the application example can be used to determine the CCT, TTT and CHT within only a few measurements. The diagram shows different cooling speeds from 850°C to Room Temperature. The same sample was cooled down several times and for each resulting curve the phase transition points were determined. The purple and dark blue curves are connecting those phase transition points and give the CCT curve for the sample.

(please look at our separate L78 Quenching & Deformation Dilatometer brochure)

**LINSEIS GmbH Germany**

Vielitzerstr. 43

95100 Selb

Tel.: (+49) 9287 880 0

E-mail: info@linseis.de

**LINSEIS Inc. USA**

109 North Gold Drive

Robbinsville, NJ 08691

Tel.: (+1) 609 223 2070

E-mail: info@linseis.de

**LINSEIS China**

Kaige Scientific Park 2653 Hunan Road

201315 Shanghai

Tel.: (+86) 61 90 12 03

Tel.: (+86) 50 55 06 42

E-mail: info@linseis.com.cn

**LINSEIS Poland**

ul. Dabrowskiego 1

05-800 Pruszków

Tel.: (+48) 692 773 795

E-mail: info@linseis.de

www.linseis.com

Products: DIL, TG, STA, DSC, HDSC, DTA, TMA, MS/FTIR, In-Situ EGA, Laser Flash, Seebeck Effect, Thin Film Analyzer, Hall-Effect

Services: Service Lab, Calibration Service

04/22

LINSEIS